



Roof Windows

Product Brochure

2017

INTRODUCING

Polar

NEW White PVC Range

keyliteroofwindows.com

Window Sizes and Product Codes

The Keylite Roof Window range is available in both standard and non-standard sizes. The matrix below can be used to establish the size and type of roof window available.

- | | |
|---|--|
| ● PCP Keylite Polar White PVC, Centre Pivot | ● TH Clear Lacquered Pine, Top Hung |
| ● CP Clear Lacquered Pine, Centre Pivot | ● WFTH White Painted Pine, Top Hung |
| ● WFCP White Painted Pine, Centre Pivot | ● FE Clear Lacquered Pine, Fire Escape |
| ● PTH Keylite Polar White PVC, Top Hung | ● WFFE White Painted Pine, Fire Escape |
| ● PFE Keylite Polar White PVC, Fire Escape | |

		Window Width (mm)					
		550	660	780	940	1140	1340
Window Height (mm)	780	01	03A	04A	07A	08A	09A
	980	02	03B	04	07B	08B	09
	1180	01C	03	05	07C	08	09C
	1400	01F	03F	06	07F	08F	10
	1600	01G	03G	04G	07	08G	09G

Legend: Standard Sizes Non-Standard Sizes

Content

INNOVATION

Why Keylite?	.04
New Keylite Polar White PVC	.06
Key Features	.10
Flick-Fit Brackets	.12
Faster, Lower, Warmer	.14



CHOICE

Natural Light For Every Room	.20
Product Selector	.22
Power Up Electric	.24
A Brighter Day	.26
Energy Efficient Glazing	.28
Integral Blind	.30
Colour With Blinds	.32

PRODUCT RANGE

Centre Pivot	.36
Fire Escape/Top Hung	.38
Conservation	.40
Combination Window Options	.42
Vertical Bi-Lite Window System	.44
Ridge Window	.45
Flat Roof Apex System	.46
Flat Roof System	.48
Combi Flat Roof System	.49
Flat Roof Dome	.50
Flat Roof Access Hatch	.51
Flat Roof Smoke Ventilation	.52
Smoke Ventilation Kit	.53
Sunlite Light Tube System	.54
Pitched Roof Sunlite System	.56
Flat Roof Sunlite System	.57

FLASHINGS AND ACCESSORIES

Single Window Flashings	.58
Combination Window Flashings	.59
Enhanced Installation Components	.60
Roof Window Support Trims	.61

BLINDS AND ACCESSORIES

Genuine Keylite Blinds	.62
Practical Features	.64
Blackout Blinds	.66
Dimout Blinds	.67
Solar Blinds	.68
Electric Blinds	.69
Kid's Range	.70
Accessories	.71

LOFT LADDER

Loft Ladder	.72
Installation Instructions	.74

Why Keylite?

Keylite's promise to our customers is to provide innovative solutions to both the products we make and the services we offer.



Extra performance, no extra costs

Keylite offers all its great features as standard, where other roof windows may require the use of additional cost accessories, just to achieve the same performance as Keylite.

Better Value!

- ✓ Expanding Thermal Collar as standard
- ✓ Recessed Fit as standard
- ✓ Warm Edge Glazing as standard



Proven design, quality materials

Keylite is part of a leading UK building materials producer which has over 30 years experience in the design and manufacture of high performance building materials for the UK and European markets.

All our timber is FSC® certified and from well managed forests, so you can be assured of our responsible environmental credentials.



Patented Innovation

Keylite's innovation guarantees that our products' performance is unique.

Our patents mean that other conventional roof windows do not share many of our extraordinary features, all of which are designed to enhance performance and simplify the installation, operation and maintenance of our products.



10 Year Guarantee

Keylite Roof Windows and Flashings are covered by a 10 year guarantee.

We are confident that our products will give trouble free performance throughout this period and beyond.

All electric components, blinds and accessories are covered by a 3 year guarantee.



Service

Keylite's technical experts are on hand to advise and assist you at the design and specification stage. When it comes to supply and delivery, our merchant stockists are at your service.

We are also available for supply of blinds and after-sales service at the contact points printed at the back of this brochure.



Approved

We take time to seek and win approval from relevant national bodies for both the company and our products. Our third party certifications give you the confidence that Keylite is the correct choice for your project.



British Standards Institution



Compliance with EU Regulation



BBA Certification for timber frame Centre Pivot Roof Windows



National Building Specification Approved



FSC® Certified*



Rainforest Alliance Certified™

*Look for FSC® certified products.

INTRODUCING

keylite

Polar[®]

PVC Roof Window Range

The Keylite Polar range combines innovative design with the latest in material technology and precision manufacturing. No other roof window provides Keylite's unique innovations for faster fitting, energy efficiency and easy maintenance as standard.

NEW IN 2017



Polar



keylite 

keylite  **Polar**

10
Year
Guarantee

Bright White

Polar combines the bright white finish of PVC with the latest in roof window design to complement the interior décor of the contemporary home.

The white interior finish blends perfectly with white ceilings to maximise the use of natural light within the room and works in harmony with the PVC windows found in modern homes.

Maintenance free

Polar's long life bright white finish is guaranteed by the use of only premium grade PVC materials ensuring that Polar remains maintenance free with only the occasional rub with a damp cloth required to retain its appearance. So unlike others there is no need to ever repaint or varnish the interior surfaces. A special self-lubricating hinge has also been added for your convenience.

Energy Efficient

The Polar range is unlike any other and features a unique built in expanding thermal collar which provides an instant barrier to heat loss and thermal bridging. It surrounds the frame with a thick insulating foam layer, filling the gap between the frame and the roof. In addition, every Polar roof window features warm edge glazing technology and gas filled glazing units to enhance overall energy efficiency.

Easily Fitted

Keylite roof windows are designed to reduce the time and effort required for installation. Our patented flick-fit brackets are pre-fitted to the window saving the installer valuable time and energy. This built in innovation enables the window to be taken from the box to the roof in just two minutes while a host of other features combine to make Keylite extremely fitter friendly.

Moisture resistant

PVC's natural resistance to moisture enables Keylite Polar roof windows to perform as equally brilliantly in a damp environment as in the dry, making them ideal for every room including even the steamiest bathroom or kitchen.



Polar



keylite 

Key Features of every Keylite Roof Window

Expanding Thermal Collar



Simply pull away the release tape to allow our unique **Expanding Thermal Collar** to expand, filling the gap between the window frame and the roof: A proven measure in reducing the cold bridging effect.



Ventilation Handle



Our slimline ventilation handle has a new **contemporary style**, designed to provide comfortable opening of both the window and ventilation flap. The handle allows for trickle ventilation, even with the window fully closed and securely locked.

Maintenance Free Hinge



The hinge, being the most **vital component** of the window, is the only operational part that moves. Keylite has eliminated the maintenance requirement of this component.



Sash Hinge Finger Springs



The sash hinge finger spring allows the sash to be installed back into the frame in one smooth, **effortless** motion.



Flick-Fit Brackets



Pre-fitted Flick-Fit brackets are easy to use and make Keylite **faster** from the box to the roof.



Click-Fit Hood & Cover Flashings

Simply **click the hood** under the clips and secure.



Streamlined Fit

Allowing the window to sit lower in the roof, the hood is designed to create a low profile.



All Weather Ventilation

Keylite Roof Windows all provide trickle ventilation, even with the window fully closed and securely locked.

Ventilation filter

The built-in insect filter ensures only clean, fresh air passes into the room.



Reinforcing Steel

For added strength and stability, the Keylite Polar range has steel added to its larger windows.



Warm Edge Glazing

All glazing is now upgraded as standard to warm edge, which **adds protection** against condensation.



Keylite Polar PVC

- Moisture resistant PVC, ideal for every room in the house including kitchens and bathrooms.
- Maintenance-free surfaces.

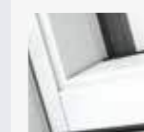

White Painted

- Durable coating.
- Ideal for contemporary interiors.



Natural Pine

- Timber with clear satin lacquer applied in multiple coats.
- Practical and hard-wearing.

Flick Fit Brackets



Our Flick-Fit brackets are pre-fitted to the window, making them fast and easy to secure into the prepared roof opening.

Further unique Keylite innovations will assist you to complete the subsequent flashing and installation process.



1. **Flick** the pre-fitted brackets at the bottom of the window into place, selecting the setting for tile or slate roofs.
2. **Position** the window in the prepared roof opening, resting the Flick-Fit brackets on the bottom lath. A projecting spur on the bracket ensures the window is set at the correct distance.
3. **Pivot** the window through the roof opening and **flick** the top brackets into place, selecting the setting for tile or slate roofs. Secure the window with screws provided.

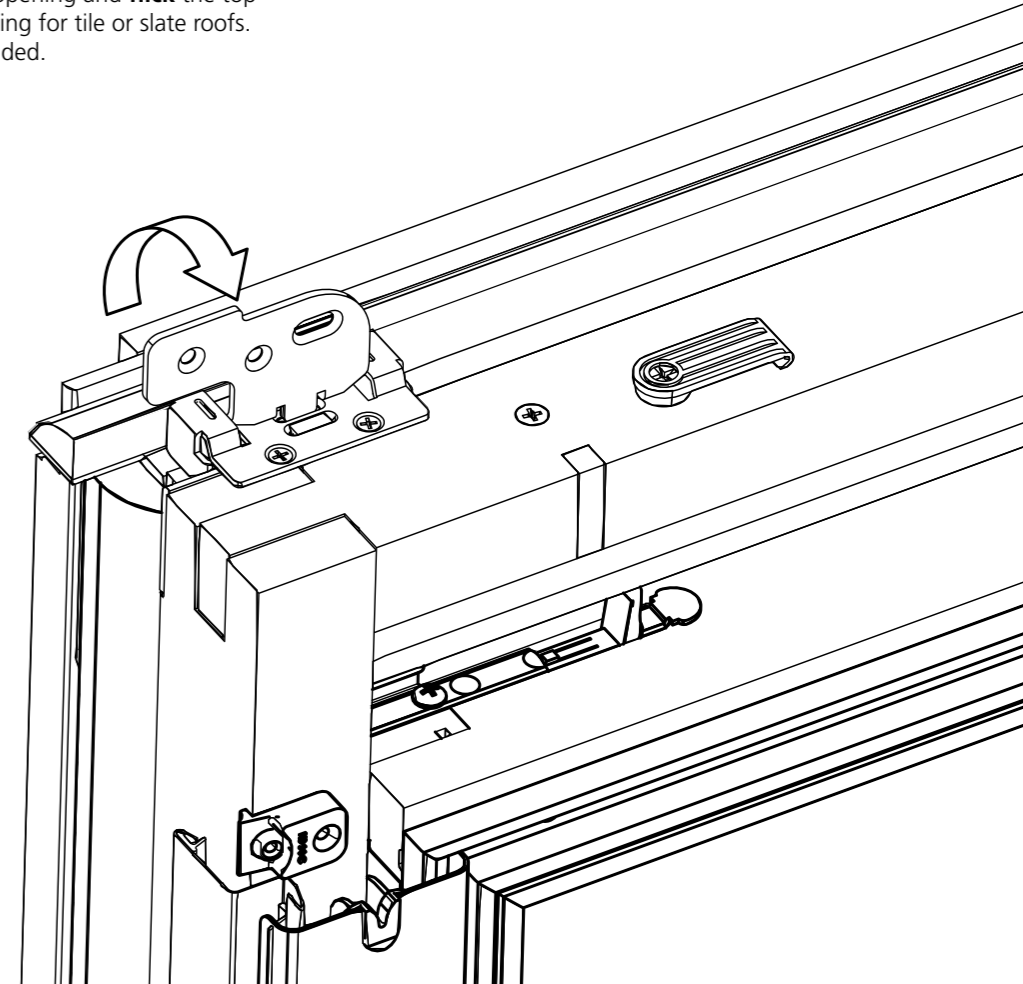

INNOVATION
AS STANDARD

Faster
Easier Installation

New innovations combined for faster, easier installation

Flick-Fit Brackets

Our unique Flick-Fit brackets are pre-fitted so you can lift the window straight from the box to the roof and simply select the setting for tile or slate.

- No loose brackets or screws.
- Fast fitting from the box to the roof.
- On product fitting instructions.



Sash Hinge Finger Springs

This unique feature controls the movement of the sash hinge fingers, enabling the installer to refit the sash into the frame in one smooth, easy motion.

- Easy fit.
- Unique feature.



Expanding Thermal Collar

Unlike other roof windows, our Thermal Collar is integrated into the window frame. The collar is activated by simply pulling release tabs for a fast insulation solution, combating cold bridging.

- No additional components to buy.
- No secondary fixing required.
- On product fitting instructions.

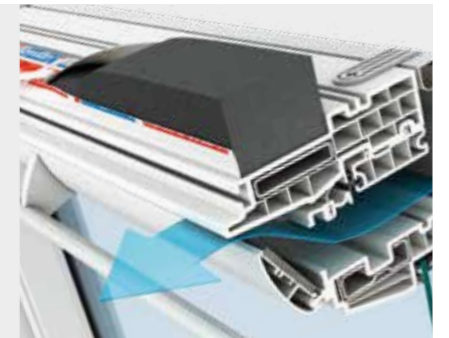

Click Fit Hood

Simply click the hood under the clips and secure. The Cover Flashings now require 50% fewer screws than before.

- Faster and easier than before.



INNOVATION
AS STANDARD

Lower

Streamlined Fit as Standard

Recessed Fit

Every Keylite roof window is recessed as standard, sitting lower in the roof than before.

The recessed fit enhances the overall appearance of the roof and improves the thermal performance of the window.

The recessed fit is achieved with Keylite's standard flashing range so there are no additional costs required.

- No additional cost.
- Improved thermal performance

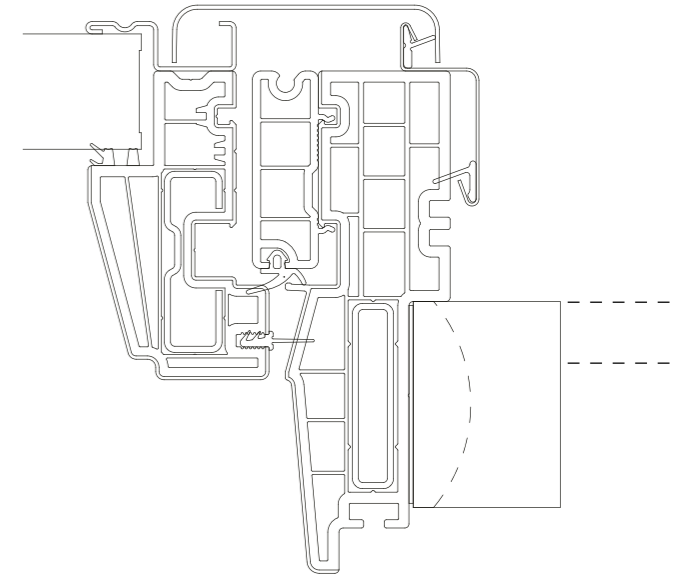

Low Profile Hood

The Keylite hood has a low profile and features a sculptured design, enhancing its profile in the roof.

- Sculptured design.
- Low profile.

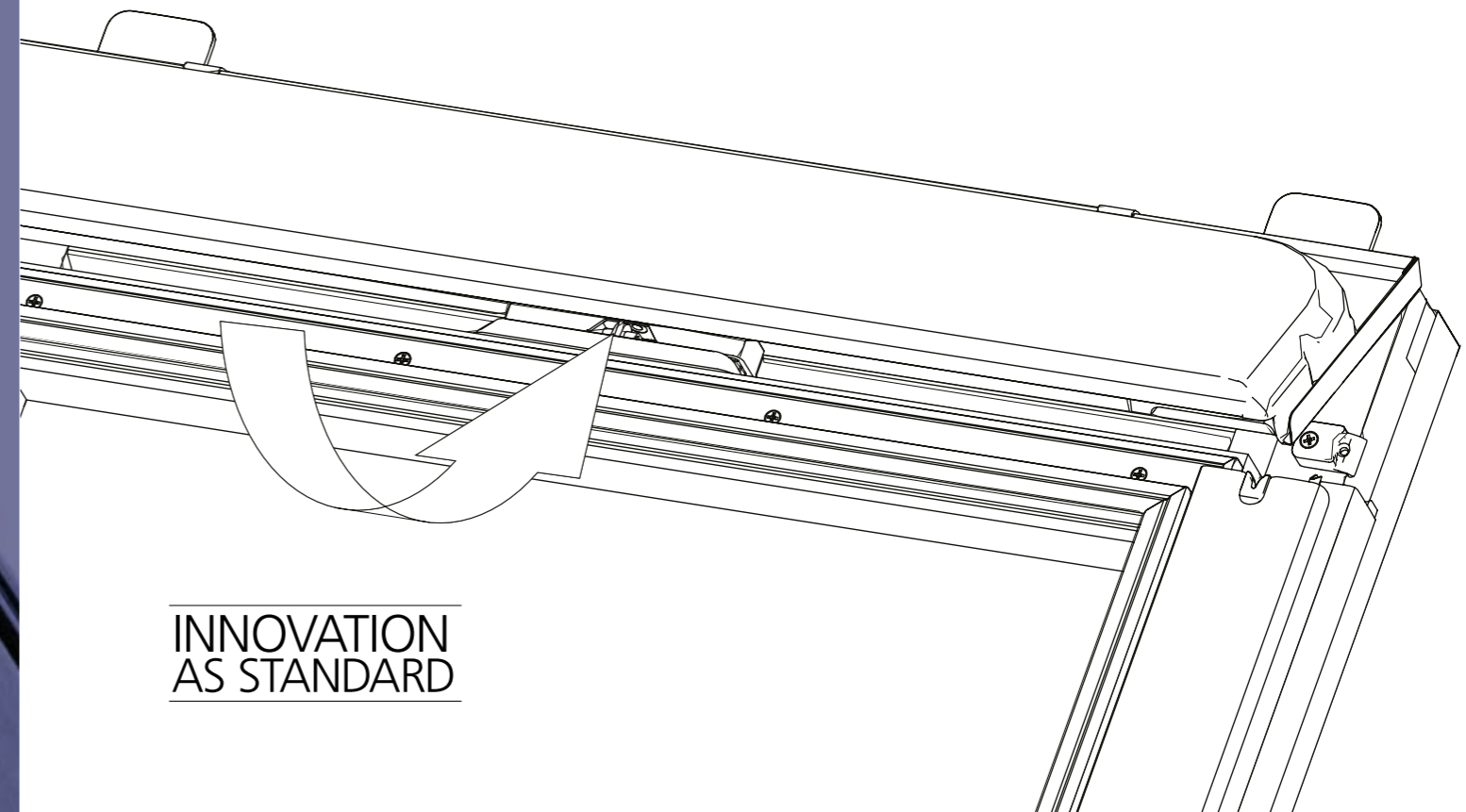

INNOVATION
AS STANDARD

Warmer Energy Efficient

Expanding thermal collar

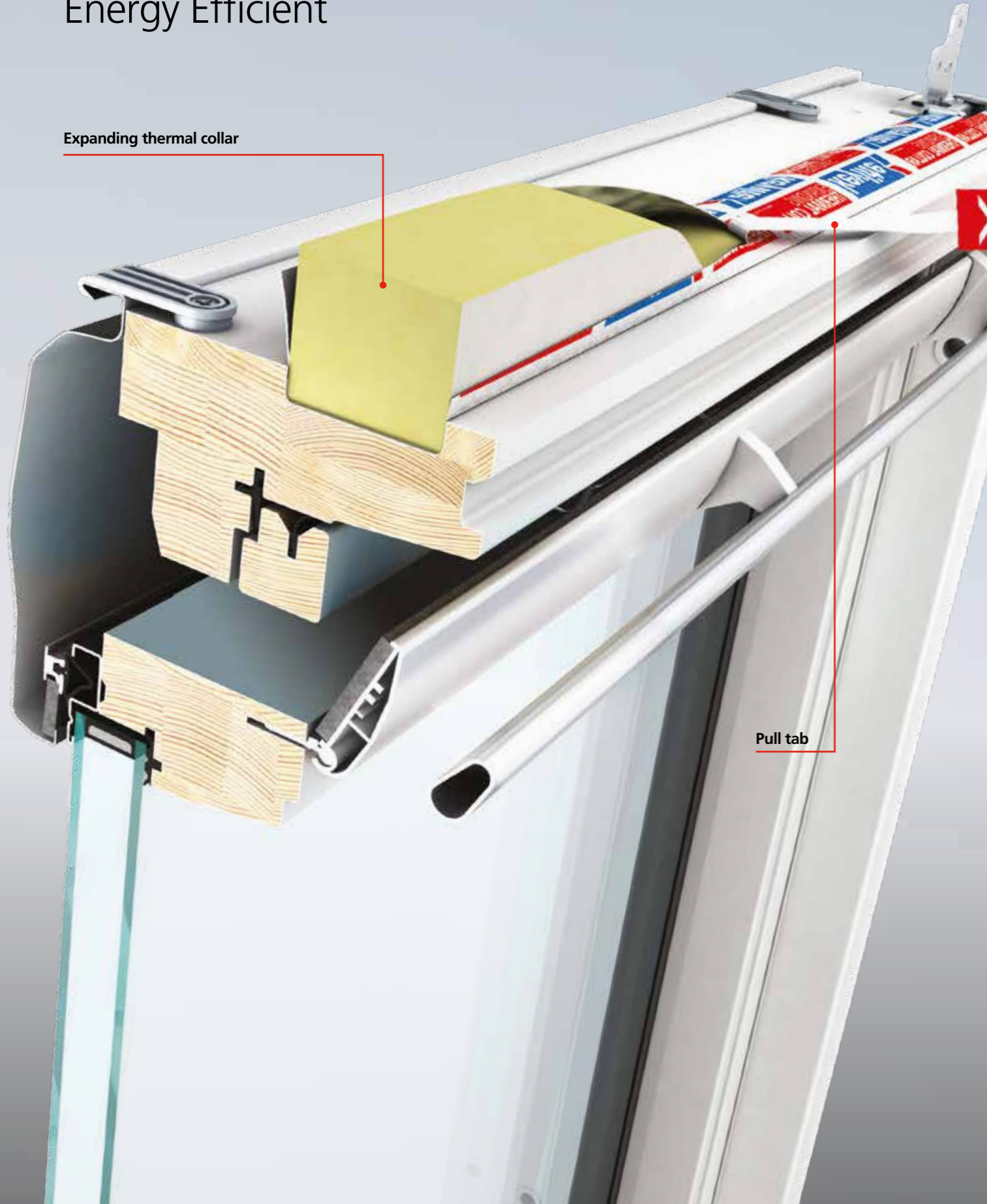

Pull tab

Expanding Thermal Collar

The Keylite innovations combine to make Keylite warmer, with enhanced U-Values.

The unique Expanding Thermal Collar fills the gap between the window frame and the roof. No other window has this feature pre-fitted as standard.

The insulation provides reduced heat loss and cold bridging, minimising the risk of condensation occurring around the window.

- Warmer installation
- Reduces condensation and eliminates cold bridging
- Improves Psi values

Keylite roof window, installed with standard recessed fit and expanded thermal collar.

**Roof opening (including 40mm gap)
U-Value:**

1.3 W/m².K

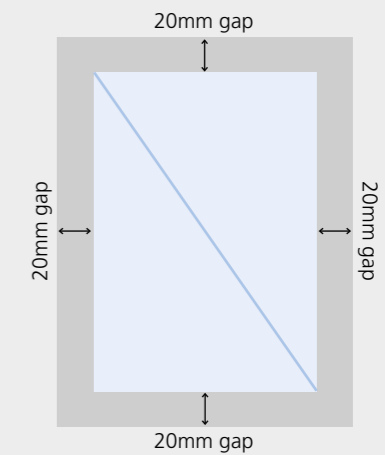

Warm Edge Glazing

Every Keylite roof window now has a Warm Edge Glazing unit as standard, to enhance the window's performance and to reduce cold bridging and condensation.

- Superior glazing unit as standard.
- Reduction in condensation.

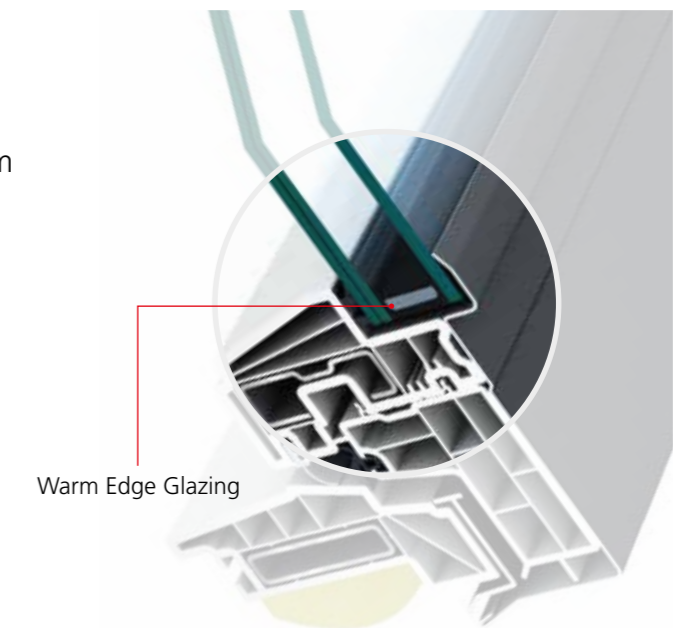

Warm Edge Glazing

**INNOVATION
AS STANDARD**

Natural Light for Every Room

While daylight levels may vary through the seasons, its direction always follows the same path, making it possible for you to optimise the light available through the positioning of your roof windows.

Options for all roof types

North Facing
These windows face away from direct sunlight. Capture more daylight by choosing larger roof windows.

South Facing
This is the optimum position to flood direct sunlight into your room

East Facing
The sun rises in the East providing direct sunlight in the morning.

West Facing
The sun sets in the West at the end of the day for evening sunlight.

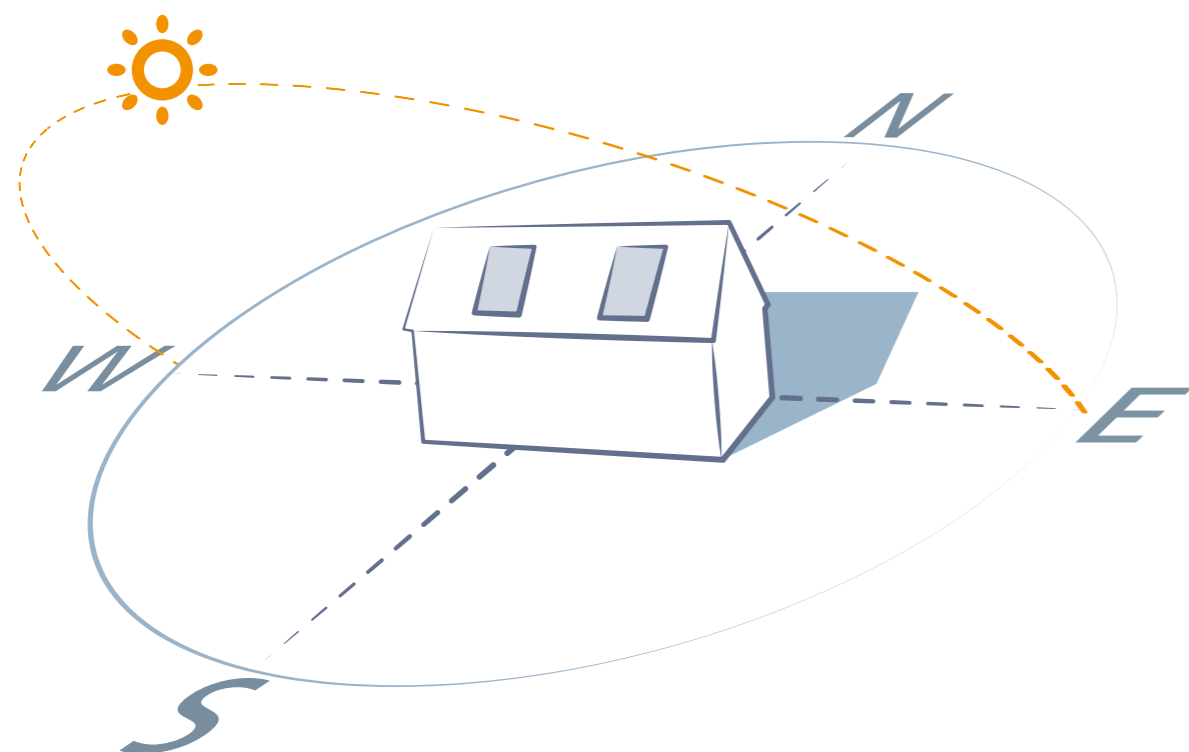

Sloping Ceilings
Keylite can provide optimum daylight and ventilation in loft conversions and new built rooms with sloping ceilings. The amount of light streaming in to the room below will be determined by your product choice.



Vertical Combinations
An impressive floor to ceiling effect can be achieved by combining vertical glazing with roof windows in a Keylite Vertical Bi-Lite.

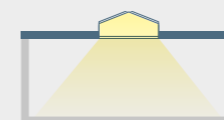

Atrium Style
The most stylish solution for flat roofs. Ideal in kitchen and living areas which will be enhanced by both the quality of the light and the aesthetic appeal of the atrium.



Vaulted Ceilings
Rooms with vaulted ceilings are dramatically enhanced by the addition of overhead roof windows. The amount of light can be controlled by the size, quantity and position of your windows.

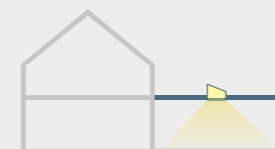

Flat Roofs
An extension need never be dark again because Keylite has a range of overhead configurations designed to suit flat roof extensions.

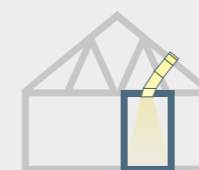

Enclosed Spaces
Even enclosed spaces can enjoy natural light by using a Keylite Sunlite to transfer light from the roof to the room below, when conventional roof windows cannot be used.

Product Selector



STEP 1



Window Style & Size

Centre Pivot

The most popular and versatile choice, suitable for most applications.

Fire Escape/Top Hung

Choose when a means of escape is required or when a 45° opening is preferred.

Conservation Window

Ideal for use in a period style property, replicating the look of a traditional sky light.

Vertical Bi-Lite

Maximise the light and ventilation in your room by combining both a pitched and vertical window.

Flat Roof Apex

These elegant overhead features provide natural daylight for spaces under flat roofs. Ideal for kitchens and living areas.

Flat Roof System

Available in single or combi formats to enable the fitting of any Keylite Roof Window onto a flat roof.

Ridge Windows

Windows installed at the highest point of a pitched ceiling create a striking feature.

STEP 2



Glazing Options

Thermal Glazing

Incorporates warm edge technology.

- Toughened outer pane.
- A centre pane U value of 1.0 W/(m².K).

Hi-Therm Glazing

Upgrade to Hi-Therm for additional safety and user features.

- Toughened outer pane and Laminated inner pane for safety.
- A centre pane U-Value of 1.0 W/(m².K).

Triple Glazing

The top performing triple glazed option provides maximum comfort.

- Toughened outer pane.
- Krypton Gas filled cavity for a centre pane U value of 0.6 W/(m².K).
- Enhanced sound and thermal insulation.

Keylite QCP

Enhanced levels of safety and security.

- P4A class glazing certified to class 2 burglary resistance under EN 1627.
- A bottom handle provides additional locking.
- All external screws are now 'non-reverse' reducing the risk of access occurring through the glazing pane.
- Further ERA 806 key operated press-bolts installed in the bottom two corners for increased security.
- Only available on Centre Pivot Windows.

STEP 3



Window Finish

Keylite Polar White PVC

Our white PVC profile is exceptionally moisture resistant and is therefore ideal as a maintenance-free solution for every room in the house including kitchens or bathrooms. The smooth surfaces of the frame are easy to clean.

White Painted Pine

Choose White Painted for a contemporary style which looks great in every room.

Clear Lacquered Pine

Our standard Pine Finish enhances the natural beauty of the wood, with a hard wearing, clear, satin lacquer applied in multiple coats. Pine Finish is a practical choice for most interiors.

STEP 4



Opening Method

Manual

Our standard windows feature an efficient manual opening and ventilation control. The top handle on our Centre Pivot window is comfortable in use, while the bottom handle on our Escape/Top Hung windows enables the user to utilise the full 45° opening range.

Electric

The electric window option provides finger-tip control, ideal for windows in high or inaccessible positions.

Options exist to combine electric opening with electric operation of blinds, to give maximum control over ventilation and shade. This can be invaluable in overhead applications.

- Fingertip control.
- Options for ventilation and shade.
- Rain sensor for auto closing.

STEP 5



Blinds

Integral Blind

The amazing integral blind is available in most window configurations. This provides an easy care solution where the blind is contained within the glazing unit, completely protecting it from damage or dust. Available in Thermal Glazing only.

Genuine Keylite Blinds

Genuine Keylite blinds are specially designed for a perfect fit and are guaranteed for 3 years.

The rail system also enables the blind to deliver thermal benefits with up to 20% reduction in heat loss.

- **Blackout Blinds** provide a 100% blackout, perfect for bedrooms or any other area where you wish to achieve darkness.
- **Dimout Blinds** provide finger-tip control of both privacy and shade for any room.

Now available with:

- **Electric Operation**
- **Solar Operation**

STEP 6

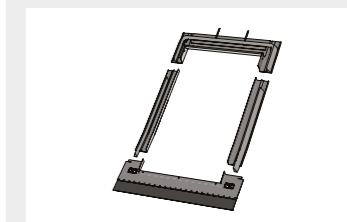

Installation Accessories

Flashings & Accessories

Keylite windows require the use of original Keylite flashings and accessories on every Keylite window installation.

- Flashing Kits.
- Vapour Collar.
- Underfelt Collar.
- Security Lock.
- Opening Restrictor.
- Opening Pole.

Power Up Electric

Centre Pivot windows installed in out of reach locations can be opened with ease by selecting the electric option.

With fingertip control of ventilation and shade, as well as a rain sensor for automatic closing in the event of rain, the electric option is recommended for all installations over 2.2m high.

Options for:

- Wall mounted control
- Thermostatic control
- Timer control
- CO² venting
- Electric blinds
- Multiple window control for commercial applications
- Retro-Fit an electric kit to your existing roof window

Available for Centre Pivot Roof Windows	Product Code
Premium Electric Window Includes motor, remote control, plug-in transformer and rain sensor.	PEK
Standard Electric Window Includes motor and hard wired transformer switch.	SEK
How to Order	
New Windows Please specify "Electric" when ordering new windows for a factory fitted solution. Specify SEK Kit or PEK Kit.	
Existing Windows Please order a kit for retro fitting to existing windows. Specify SEK Kit or PEK Kit.	
Technical Support	

Installation
Please visit www.keyliteroofwindows.com to view installation details.

Multiple Window Operations
Please contact the Keylite Technical Team for commercial projects and multiple window operations.



Rain Sensor for auto closing



Hand held remote control



Premium Electric Window

- Pre-fitted to window.
- Simply plug it in! No need for complex wiring.
- Multi window function options.
- Available with Automatic Blinds.

A Brighter Day

Go bigger to bring more sky inside and make every day brighter.

Choose larger windows, or install multiple windows, to create a completely different feel in any room. Keylite has a wide range of options, allowing you to maximise both light and ventilation.

- Multi-window options for every project.
- Vertical Bi-Lites for floor to ceiling views.

For further information on Multi-window options and Vertical Bi-Lites see **pages 44-45**



Energy Efficient Glazing

Choose a high performance glazing option to maximise energy efficiency.

Keylite Roof Windows can be supplied with a wide range of glazing variants including thermal properties, tinted, frosted and self-cleaning glass.

Standard Glazing

Thermal (T)

- 4mm toughened outer pane.
- 20mm Argon gas filled cavity.
- 4mm inner pane.
- Warm edge glazing unit.

Glazing Type	Ug W/(m ² .K)	Rw, r dB	g	Tv	Tuv
T (Thermal)	1.0	32	59.8	80.1	35.0



Hi-Therm (HT)

- 4mm toughened outer pane.
- 18mm Argon gas filled cavity.
- 6mm laminated inner pane.
- Ideal safety glazing for windows below 800mm from finish floor level or windows above head height.
- Improves sound reduction, safety and a reduction in the harmful effects of UV light.
- Warm edge glazing unit.

Glazing Type	Ug W/(m ² .K)	Rw, r dB	g	Tv	Tuv
HT (Hi-Therm)	1.0	36	59.5	79.5	3.7



Triple (KTG)

- 4mm toughened outer pane.
- 10mm Krypton gas filled cavity.
- 4mm centre pane
- 8mm Krypton gas filled cavity.
- 4mm inner pane
- Triple glazing offers a lower U value.
- Warm edge glazing unit.

Glazing Type	Ug W/(m ² .K)	Rw, r dB	g	Tv	Tuv
KTG (Triple)	0.6	32	49.8	70.9	19.9



Integral (I)

- An integral blind sealed in the glazing unit, offering protection against moisture and dust.
- 4mm toughened on outer pane.
- 20mm Argon gas filled cavity.
- 4mm inner pane.
- Options for manual or electrical operation.
- Ideal for kitchens and bathrooms.

See [page 30](#) for further information.



Note: U-Value is based on a centre pane measurements. Integral blind glazing unit is manufactured with thermal glazing and is not available with triple or Hi-therm glazing.

Glazing Options

Bronze (BRT)



Frosted (FR)



Self-Cleaning (SC)



Integral Blind

The roof window with a blind sealed inside the glass for protection against moisture, dust and damage.

- Factory-fitted blind, sealed inside the energy efficient double glazed unit.
- Requires no cleaning - ideal for sterile and/or hygienic environments e.g. hospitals or surgeries.
- Provides enhanced sun-shading and improves the U-value of the sealed unit.
- Available in manual or electric options.

Glazing Type	Ug W/(m ² .K)	Rw, r dB	g	Tv	Tuv
I (Integral Blind)	1.0	32	59.8	80.1	35.0



Colour with Blinds

Choose from the extensive range of genuine Keylite blinds for control of light and privacy, co-ordinating perfectly with your home.

- Easy to install and use
- Options for Blackout or Dimout
- Upgrade to electric or solar power

See **page 62** for more details.



Product Range

Index

ROOF WINDOWS

Centre Pivot.....	36
Fire Escape/Top Hung.....	38
Conservation.....	40

COMBINATIONS

Combination Window Options.....	42
Vertical Bi-Lite Window System.....	44
Ridge Window.....	45

FLAT ROOF SYSTEMS

Flat Roof Apex System.....	46
Flat Roof System.....	48
Combi Flat Roof System.....	49
Flat Roof Dome.....	50
Flat Roof Access Hatch.....	51

SMOKE VENTILATION

Flat Roof Smoke Ventilation.....	52
Smoke Ventilation Kit.....	53

SUN TUNNELS

Sunlite Light Tube System.....	54
Pitched Roof Sunlite System.....	56
Flat Roof Sunlite System.....	57

FLASHINGS AND ACCESSORIES

Single Window Flashings.....	58
Combination Window Flashings.....	59
Enhanced Installation Components.....	60
Roof Window Support Trims.....	61

BLINDS AND ACCESSORIES

Genuine Keylite Blinds.....	62
Practical Features.....	64
Blackout Blinds.....	66
Dimout Blinds.....	67
Solar Blinds.....	68
Electric Blinds.....	69
Kid's Blinds.....	70
Accessories.....	71

LOFT LADDER

Loft Ladder.....	72
Installation Instructions.....	74

Centre Pivot Roof Windows

CP



Our most versatile window, suitable for single or multiple applications in any roof with a pitch of 15°-90°.

The opening handle is conveniently placed at the top of the window and also controls ventilation, giving the option of fresh air flow even when the window is locked and secure.



Features

- Easy Cleaning**
 The window rotates through 180° and locks in place, allowing easy access to the outer surface of the glass which can be cleaned from inside the room.
- Easy Maintenance**
 Due to the quality of the lacquered finish and an innovative maintenance free hinge, Keylite windows are extremely easy to maintain
- Versatility**
 Please refer to our full range of upgrades and options that increase the versatility of the Centre Pivot range.
- Thermal Performance**
 Only Keylite windows have an Expanding Thermal Collar, Warm Edge Glazing and a Streamlined Fit as standard, leading to enhanced thermal performance.
- Effective Ventilation**
 An initial short pull downwards on the handle opens the ventilation flap while the window is still securely closed; a further gentle pull opens the window.
- Keylite QCP**
 Our new Secure Roof Window offers enhanced levels of safety and security. It features P4A class glazing certified to class 2 burglary resistance under EN 1627. A bottom handle provides additional locking. All external screws are now 'non-reverse' reducing the risk of access occurring through the glazing pane.

Size Code	01	02	01C	03	04	05	06	07F	07	08	09	10
Size WxH (mm)	550x780	550x980	550x1180	660x1180	780x980	780x1180	780x1400	940x1400	940x1600	1140x1180	1340x980	1340x1400
Keylite Polar White PVC												
PCP T Thermal Glazing	PCP01T	PCP02T	PCP01CT	PCP03T	PCP04T	PCP05T	PCP06T	PCP07FT	-	PCP08T	PCP09T	PCP10T
PCP HT Hi Therm Glazing	PCP01HT	PCP02HT	PCP01CHT	PCP03HT	PCP04HT	PCP05HT	PCP06HT	PCP07FHT	-	PCP08HT	PCP09HT	-
PCP KTG Triple Glazing	PCP01KTG	PCP02KTG	PCP01CKTG	PCP03KTG	PCP04KTG	PCP05KTG	PCP06KTG	PCP07FKTG	-	PCP08KTG	PCP09KTG	-
PCP I Integral Blind	PCP01I	PCP02I	PCP01CI	PCP03I	PCP04I	PCP05I	PCP06I	PCP07FI	-	PCP08I	PCP09I	-
White Painted Pine												
WFCP T Thermal Glazing	WFCP01T	WFCP02T	WFCP01CT	WFCP03T	WFCP04T	WFCP05T	WFCP06T	WFCP07FT	WFCP07T	WFCP08T	WFCP09T	WFCP10T
WFCP HT Hi Therm Glazing	WFCP01HT	WFCP02HT	WFCP01CHT	WFCP03HT	WFCP04HT	WFCP05HT	WFCP06HT	WFCP07FHT	WFCP07HT	WFCP08HT	WFCP09HT	WFCP10HT
WFCP KTG Triple Glazing	WFCP01KTG	WFCP02KTG	WFCP01CKTG	WFCP03KTG	WFCP04KTG	WFCP05KTG	WFCP06KTG	WFCP07FKTG	WFCP07KTG	WFCP08KTG	WFCP09KTG	WFCP10KTG
WFQCP HT Security Glazing	WFQCP01HT	WFQCP02HT	WFQCP01CHT	WFQCP03HT	WFQCP04HT	WFQCP05HT	WFQCP06HT	WFQCP07FHT	WFQCP07HT	WFQCP08HT	WFQCP09HT	WFQCP10HT
WFCP I Integral Blind	WFCP01I	WFCP02I	WFCP01CI	WFCP03I	WFCP04I	WFCP05I	WFCP06I	WFCP07FI	WFCP07I	WFCP08I	WFCP09I	-
Clear Lacquered Pine												
CP T Thermal Glazing	CP01T	CP02T	CP01CT	CP03T	CP04T	CP05T	CP06T	CP07FT	CP07T	CP08T	CP09T	CP10T
CP HT Hi Therm Glazing	CP01HT	CP02HT	CP01CHT	CP03HT	CP04HT	CP05HT	CP06HT	CP07FHT	CP07HT	CP08HT	CP09HT	CP10HT
CP KTG Triple Glazing	CP01KTG	CP02KTG	CP01CKTG	CP03KTG	CP04KTG	CP05KTG	CP06KTG	CP07FKTG	CP07KTG	CP08KTG	CP09KTG	CP10KTG
QCP HT Security Glazing	QCP01HT	QCP02HT	QCP01CHT	QCP03HT	QCP04HT	QCP05HT	QCP06HT	QCP07FHT	QCP07HT	QCP08HT	QCP09HT	QCP10HT
CP I Integral Blind	CP01I	CP02I	CP01CI	CP03I	CP04I	CP05I	CP06I	CP07FI	CP07I	CP08I	CP09I	-



Fire Escape/Top Hung

FE/TH



The Keylite Fire Escape Roof Window opens to 45°, complying with statutory regulations.

This is ideal in low pitch roofs as the window opens outward, maximising the daylight that enters the room without the sash encroaching on your valuable internal space.

Features

- Means of Escape**
 As a means of escape, the window opens to an unobstructed area for safe exit, in the event of an emergency. The opening handle located at the bottom of the window is easily accessible.
- Easy to Use**
 The multi-stop opening feature allows the user to simply push the window to any position between 0° and 45° and remain open for maximum flexibility.

Fire Escape

- Effective Ventilation**
 Effective ventilation is provided by the vent flap at the top of the window which regulates the air flow, even when the window is closed.
- Thermal Performance**
 Only Keylite windows have an Expanding Thermal Collar, Warm Edge Glazing and a Streamlined Fit as standard, leading to enhanced thermal performance.
- The window should have an unobstructed openable area that is at least 0.33m² and at least 450mm high and 450mm wide.

Size Code	01	02	01C	03	04	05	06	07F	07	08	09	10
Size WxH (mm)	550x780	550x980	550x1180	660x1180	780x980	780x1180	780x1400	940x1400	940x1600	1140x1180	1340x980	1340x1400
Keylite Polar White PVC												
PFE T Thermal Glazing	-	PTH02T*	PFE01CT	PFE03T	PFE04T	PFE05T	PFE06T	PFE07FT	-	PFE08T	PFE09T	-
PFE HT Hi Therm Glazing	-	PTH02HT*	PFE01CHT	PFE03HT	PFE04HT	PFE05HT	PFE06HT	PFE07FHT	-	PFE08HT	PFE09HT	-
PFE KTG Triple Glazing	-	PTH02KTG*	PFE01CKTG	PFE03KTG	PFE04KTG	PFE05KTG	PFE06KTG	PFE07FKTG	-	PFE08KTG	-	-
PFE I Integral Blind	-	PTH02I*	PFE01CI	PFE03I	PFE04I	PFE05I	PFE06I	PFE07FI	-	PFE08I	PFE09I	-
White Painted Pine												
WFFE T Thermal Glazing	-	WFTH02T*	WFFE01CT	WFFE03T	WFFE04T	WFFE05T	WFFE06T	WFFE07FT	WFFE07T	WFFE08T	WFFE09T	WFFE10T
WFFE HT Hi therm Glazing	-	WFTH02HT*	WFFE01CHT	WFFE03HT	WFFE04HT	WFFE05HT	WFFE06HT	WFFE07FHT	WFFE07HT	WFFE08HT	WFFE09HT	-
WFFE KTG Triple Glazing	-	WFTH02KTG*	WFFE01CKTG	WFFE03KTG	WFFE04KTG	WFFE05KTG	WFFE06KTG	WFFE07FKTG	WFFE07KTG	WFFE08KTG	-	-
WFFE I Integral Blind	-	WFTH02I*	WFFE01CI	WFFE03I	WFFE04I	WFFE05I	WFFE06I	WFFE07FI	WFFE07I	WFFE08I	WFFE09I	-
Clear Lacquered Pine												
FE T Thermal Glazing	-	TH02T*	FE01CT	FE03T	FE04T	FE05T	FE06T	FE07FT	FE07T	FE08T	FE09T	FE10T
FE HT Hi Therm Glazing	-	TH02HT*	FE01CHT	FE03HT	FE04HT	FE05HT	FE06HT	FE07FHT	FE07HT	FE08HT	FE09HT	-
FE KTG Triple Glazing	-	TH02KTG*	FE01CKTG	FE03KTG	FE04KTG	FE05KTG	FE06KTG	FE07FKTG	FE07KTG	FE08KTG	-	-
FE I Integral Blind	-	TH02I*	FE01CI	FE03I	FE04I	FE05I	FE06I	FE07FI	FE07I	FE08I	FE09I	-

*Due to opening size an 02 roof window must not be used as a means of escape.



Conservation Roof Windows

CW



The Keylite Conservation Roof Window is designed to complement both renovation and new build projects in a traditional style.

The black central glazing bar and low profile external flashing maintain the traditional character of the building, whilst still accommodating the flow of natural light to the interior below.



Features

- **Classic Design** - While traditional in its external appearance, the standard Conservation Roof Window benefits from all of the advanced Keylite features including thermal efficiency, low maintenance and ventilation control.
- **Centre Pivot** - Centre Pivot Conservation Roof Windows available in Pine, White Finish and PVC.
- **Top Hung** - Top Hung/Fire Escape Conservation Roof Windows available in PVC, Pine or White Finish.
- **Thermal Performance** - Only Keylite windows have an Expanding Thermal Collar, Warm Edge Glazing and a Streamlined Fit as standard, leading to enhanced thermal performance.



Size Code	01	02	01C	03	04	05	06	07F	07	08	09	10
Size WxH (mm)	550x780	550x980	550x1180	660x1180	780x980	780x1180	780x1400	940x1400	940x1600	1140x1180	1340x980	1340x1400



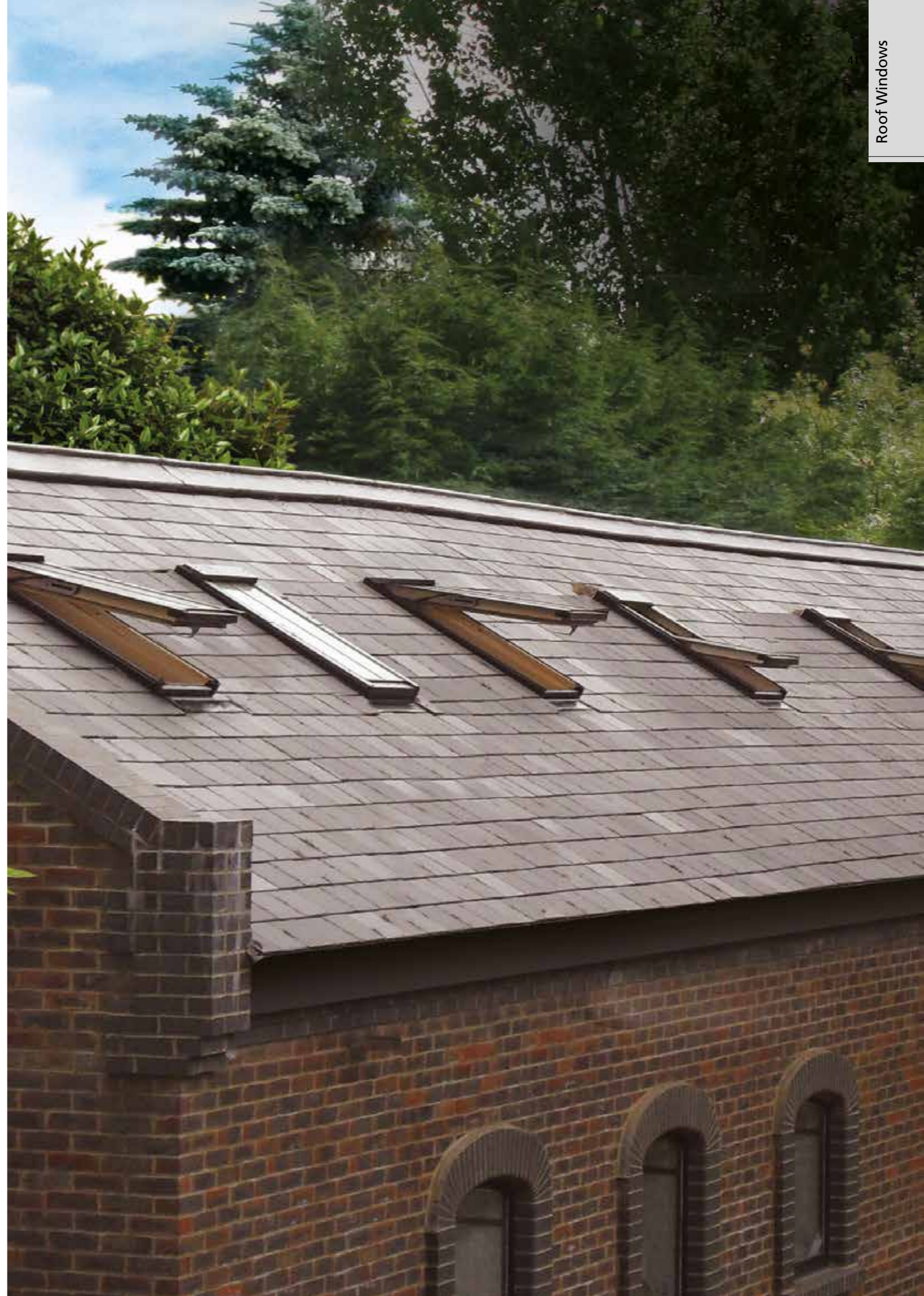

Keylite Polar White PVC													
NEW	CWPCP T Centre Pivot Thermal Glazing	CWPCP01T	CWPCP02T	CWPCP01CT	CWPCP03T	CWPCP04T	CWPCP05T	CWPCP06T	CWPCP07FT	-	CWPCP08T	CWPCP09T	CWPCP10T
	CWPFE T Top Hung Thermal Glazing	-	CWPTH02T*	CWPFE01CT	CWPFE03T	CWPFE04T	CWPFE05T	CWPFE06T	CWPFE07FT	-	CWPFE08T	CWPFE09T	-
White Painted Pine													
	CWWFCP T Centre Pivot Thermal Glazing	CWWFCP01T	CWWFCP02T	CWWFCP01CT	CWWFCP03T	CWWFCP04T	CWWFCP05T	CWWFCP06T	CWWFCP07FT	CWWFCP07T	CWWFCP08T	CWWFCP09T	CWWFCP10T
	CWWFFE T Top Hung Thermal Glazing	-	CWWFTH02T*	CWWFFE01CT	CWWFFE03T	CWWFFE04T	CWWFFE05T	CWWFFE06T	CWWFFE07FT	CWWFFE07T	CWWFFE08T	CWWFFE09T	CWWFFE10T
Clear Lacquered Pine													
	CWCP T Centre Pivot Thermal Glazing	CWCP01T	CWCP02T	CWCP01CT	CWCP03T	CWCP04T	CWCP05T	CWCP06T	CWCP07FT	CWCP07T	CWCP08T	CWCP09T	CWCP10T
	CWFE T Top Hung Thermal Glazing	-	CWTH02T*	CWFE01CT	CWFE03T	CWFE04T	CWFE05T	CWFE06T	CWFE07FT	CWFE07T	CWFE08T	CWFE09T	CWFE10T

*Due to opening size an 02 roof window must not be used as a means of escape.



Combination Window Options

The Keylite Technical Team will assist you to specify the optimum solution for your project and create an order schedule for combination windows and flashings.

<p>STEP 1 Choose your roof windows</p> <ul style="list-style-type: none"> • Style • Size • Electric or manual opening • Surface, Integral or Electric blinds 	<p>STEP 2 Choose your window layout</p> <p>Combi System Side by side on a horizontal plane</p>  <p>Bi-Lite System One over the other on a vertical plane</p>  <p>Grid System Multiple windows in grid formation</p> 	<p>STEP 3 Spacing between windows</p> <ul style="list-style-type: none"> • 100mm • 50mm (on Combi System only) • 18mm (on Combi System only) <p>STEP 4 Flashing</p> <ul style="list-style-type: none"> • Tile Roof • Slate Roof • Plain Tile Roof - Combi System only <p>STEP 5 Finish</p> <p>Choose White or Pine Internal Support Trimmers</p>
--	--	---



Build your combination roof window specification online at

keyliteroofwindows.com



Vertical Bi-Lite Window System

VBL



The Vertical Bi-Lite is a vertical window component, which combines with a Keylite Roof Window to produce an attractive glazing feature.

This is a highly effective way to maximise the levels of light and ventilation in any room.

Optional upgrades are also available, for further information please contact the Keylite Sales Team.

Follow these steps when choosing a vertical window to combine with your roof window.

STEP 1
Decide if the system you require is a single, double or triple.

STEP 2
Select your roof window(s) in size 04, 05, 06. Choose from:

- Integral Windows
- Pine or White Finish
- Centre Pivot
- Top Hung

STEP 3
Specify if your vertical window is:

- 600mm deep (Tilt only available)
- 950mm deep (Tilt only or Tilt & Turn available)

Note: 950mm Tilt & Turn can qualify as a means of escape in certain sizes, please contact the Keylite Technical Team for more information.

STEP 4
Flashing is included with the price of your vertical window so please specify your roof finish (slate or tile) and roof pitch.

Length of Roof Window(s) (mm)	980, 1180, 1400
Height of Vertical Window(s) (mm)	600, 950
Width of Vertical Bi-Lites (mm)	
Single	780
Double	1570
Triple	2370
Pitch	Min 20°, Max 55°

Tilt + Turn is only available on 780mm wide, 950mm high vertical windows (single, double & triple).

Note: For VBL Systems outside the above please contact Keylite Sales Team.

Size Code	Single	Double	Triple
Size (W)	780	1570	2370
Clear Lacquered Pine			
H = 600mm Tilt only	VBL 780X600 T	VBL 780X600 T 2018	VBL 780X600 T 3018
H = 950mm Tilt only	VBL 780X950 T	VBL 780X950 T 2018	VBL 780X950 T 3018
H = 950mm Tilt and Turn	VBL 780X950 TT	VBL 780X950 TT 2018	VBL 780X950 TT 3018

White Painted Pine is also available - please prefix all the above codes with 'WF' e.g. WFBVL 780X950 T.



Ridge Window

RG



Keylite Ridge Roof Windows may be installed along the roof ridge to maximise light and space at the highest point of the pitched ceiling.



Features

- Keylite Ridge Roof Windows are ideal for both domestic and commercial applications, and are available for the following ranges: Centre Pivot, Conservation and White Finish Roof Windows, all with the option of an Integral Blind.
- Usually installed in out of reach locations, these roof windows may be electrically operated by hand-held remote control or a wall-mounted switch.
- Electrical options for windows with integral blinds provide control over daylight and ventilation.
- Easy-to-install features, including flick-fit brackets.

Installation

- The installation of Keylite Ridge Roof Windows is very similar to standard roof window installation.
- The roof windows must be positioned in a way to avoid the sashes colliding when opened.

Size Code	01	02	01C	03	04	05	06	07F	07	08	09	10
Size WxH (mm)	550x780	550x980	550x1180	660x1180	780x980	780x1180	780x1400	940x1400	940x1600	1140x1180	1340x980	1340x1400
RGSRF Single Ridge Slate Flashing	RGSRF 01	RGSRF 02	RGSRF 01C	RGSRF 03	RGSRF 04	RGSRF 05	RGSRF 06	RGSRF 07F	RGSRF 07	RGSRF 08	RGSRF 09	RGSRF 10
RGTRF Single Ridge Tile Flashing	RGTRF 01	RGTRF 02	RGTRF 01C	RGTRF 03	RGTRF 04	RGTRF 05	RGTRF 06	RGTRF 07F	RGTRF 07	RGTRF 08	RGTRF 09	RGTRF 10
CRGSRF Combi Ridge Slate Flashing	CRGSRF 01	CRGSRF 02	CRGSRF 01C	CRGSRF 03	CRGSRF 04	CRGSRF 05	CRGSRF 06	CRGSRF 07F	CRGSRF 07	CRGSRF 08	CRGSRF 09	CRGSRF 10
CRGTRF Combi Ridge Tile Flashing	CRGTRF 01	CRGTRF 02	CRGTRF 01C	CRGTRF 03	CRGTRF 04	CRGTRF 05	CRGTRF 06	CRGTRF 07F	CRGTRF 07	CRGTRF 08	CRGTRF 09	CRGTRF 10

Note: Windows that are 280mm or more down from the ridge can be fitted using Standard Keylite Flashings. Windows that are less than 280mm will have to be fitted with the Keylite Ridge Flashings. Please specify Tile, Slate or Plain Tile Flashings when placing your order. (Plain Tile = TRF). Also available for Top Hung and Conservation Windows. Product code does not include windows.

Flat Roof Apex System

FRX



The Keylite Flat Roof Apex System creates a sophisticated, atrium style roof window, capable of adding function and style to living spaces under flat roofs.



Features

- Ideal for kitchens or living areas, the system in single, double or triple formats can totally transform the room with floods of natural light.
- The system is supplied complete with the chosen roof windows plus the fully insulated upstand and precision flashings.
- Choose the white surface for high moisture resistance and a particularly practical use in the kitchen.
- Electrical options for windows with integral blinds provide control over daylight and ventilation.

Size Code	01	02	01C	03	04	05	06	07F	07	08	09	10
Size WxH (mm)	550x780	550x980	550x1180	660x1180	780x980	780x1180	780x1400	940x1400	940x1600	1140x1180	1340x980	1340x1400
FRX Single Apex System	FRX 01	FRX 02	FRX 01C	FRX 03	FRX 04	FRX 05	FRX 06	-	FRX 07	FRX 08	-	-
CFRX 2018 Double Apex System	CFRX 01 2018	CFRX 02 2018	CFRX 01C 2018	CFRX 03 2018	CFRX 04 2018	CFRX 05 2018	CFRX 06 2018	-	CFRX 07 2018	CFRX 08 2018	-	-
CFRX 3018 Triple Apex System	CFRX 01 3018	CFRX 02 3018	CFRX 01C 3018	CFRX 03 3018	CFRX 04 3018	CFRX 05 3018	CFRX 06 3018	-	CFRX 07 3018	-	-	-

Note: Product codes include timber upstand and corresponding flashings. Roof windows are not included. Please contact Keylite Technical Team regarding structural opening sizes.



Flat Roof System FRS



Many properties have extensions with flat or near flat roofs. Keylite has developed a Flat Roof System specifically for this application, which allows daylight into the area beneath.

The Keylite Flat Roof System provides all the benefits of natural ventilation and daylight. All roof windows within the entire Keylite range can be integrated within a Flat Roof System.



Standard System Includes

- An insulated timber upstand.
- FRS Flashings to integrate the window onto the timber upstand.
- Ideal solution for Warm Roof applications below 15°.

Installation

- For the installation of roof windows over 2.2m, Keylite also recommend an electrical control unit and a laminated inner pane.

Size Code	01	02	03	04	05	06	07	08	09	10
Roof Window Size WxH (mm)	550x780	550x980	660x1180	780x980	780x1180	780x1400	940x1600	1140x1180	1340x980	1340x1400
Structural Opening Size	530x1000	530x1200	640x1400	760x1200	760x1400	760x1620	920x1820	1120x1400	1320x1200	1320x1620
FRS Flat roof system with insulated timber upstand and flashing for one window	FRS 01	FRS 02	FRS 03	FRS 04	FRS 05	FRS 06	FRS 07	FRS 08	FRS 09	FRS 10
FRSF Flat roof system flashing for one window	FRSF 01	FRSF 02	FRSF 03	FRSF 04	FRSF 05	FRSF 06	FRSF 07	FRSF 08	FRSF 09	FRSF 10
FRSU Flat roof system with timber upstand for one window	FRSU 01	FRSU 02	FRSU 03	FRSU 04	FRSU 05	FRSU 06	FRSU 07	FRSU 08	FRSU 09	FRSU 10

Note: The codes above refer to the flashing and upstand only, for a complete system a roof window must be specified separately. For further information please contact the Keylite Technical Team.

Combi Flat Roof System CFRS



A practical solution to the installation of pairs of roof windows in a flat roof. The system is completely pre-fabricated for ease of installation on-site.



Features

- Keylite Flat Roof System comes complete with a shaped, insulated wooden kerb and flashing kit.
- To maximise the amount of natural light entering the room, the front and back framing is angled.
- The system is also available with Keylite Electric Operation and Smoke Ventilation Systems.

Installation

- For the installation of roof windows over 2.2m, Keylite also recommends an electrical control unit and a laminated inner pane.

Size Code	01	02	03	04	05	06	07	08	09	10
Roof Window Size WxH (mm)	1120x780	1120x980	1340x1180	1580x980	1580x1180	1580x1400	1900x1600	2300x1180	2700x980	2700x1400
Structural Opening Size	1100x1000	1100x1200	1320x1400	1560x1200	1560x1400	1560x1620	1880x1820	2280x1400	2680x1200	2680x1620
CFRS 2018 Flat roof system with insulated timber upstand and flashing for one window	CFRS 01 2018	CFRS 02 2018	CFRS 03 2018	CFRS 04 2018	CFRS 05 2018	CFRS 06 2018	CFRS 07 2018	CFRS 08 2018	CFRS 09 2018	CFRS 10 2018
CFRSF 2018 Flat roof system flashing for one window	CFRSF 01 2018	CFRSF 02 2018	CFRSF 03 2018	CFRSF 04 2018	CFRSF 05 2018	CFRSF 06 2018	CFRSF 07C 2018	CFRSF 08C 2018	CFRSF 09C 2018	CFRSF 10 2018
CFRSU 2018 Flat roof system with timber upstand for one window	CFRSU 01 2018	CFRSU 02 2018	CFRSU 03 2018	CFRSU 04 2018	CFRSU 05 2018	CFRSU 06 2018	CFRSU 07 2018	CFRSU 08 2018	CFRSU 09 2018	CFRSU 10 2018

Note: The codes above refer to the flashing and upstand only, for a complete system a roof window must be specified separately. For further information please contact the Keylite Technical Team.

Flat Roof Dome

FRD



Keylite Flat Roof Domes are thermoformed with a triple skin construction.

Polycarbonate is virtually unbreakable, with an impact strength 250 times greater than glass. Keylite Flat Roof Domes can be supplied with a clear or frosted finish.



Features

- Triple skin polycarbonate (clear or frosted) and PVC 150mm splayed upstand.
- U-Value of 1.3W/(m².K).
- Patented security screwbolts.
- 10 year rooflight / 1 year accessories guarantee.
- Extended range of ventilation, access, up-stands also available upon request.

Flat Roof Dome Code	S6	R69	S8	S9	R912	S10	R1015	S12	S15
Size WxL (mm)	600x600	600x900	800x800	900x900	900x1200	1000x1000	1000x1500	1200x1200	1500x1500
Structural Opening Size	625x625	625x925	825x825	925x925	925x1225	1025x1025	1025x1525	1225x1225	1525x1525
Fixed Product Codes									
Clear	FRD S6	FRD R69	FRD S8	FRD S9	FRD R912	FRD S10	FRD R1015	FRD S12	FRD S15
Frosted	FRD S6 FR	FRD R69 FR	FRD S8 FR	FRD S9 FR	FRD R912 FR	FRD S10 FR	FRD R1015 FR	FRD S12 FR	FRD S15 FR
Manual Opening Product Codes									
Clear	FRD S6 M	FRD R69 M	FRD S8 M	FRD S9 M	FRD R912 M	FRD S10 M	FRD R1015 M	FRD S12 M	FRD S15 M
Frosted	FRD S6 FR M	FRD R69 FR M	FRD S8 FR M	FRD S9 FR M	FRD R912 FR M	FRD S10 FR M	FRD R1015 FR M	FRD S12 FR M	FRD S15 FR M
Electric Opening Product Code (Electric Switch)									
Clear	FRD S6 ES	FRD R69 ES	FRD S8 ES	FRD S9 ES	FRD R912 ES	FRD S10 ES	FRD R1015 ES	FRD S12 ES	FRD S15 ES
Frosted	FRD S6 FR ES	FRD R69 FR ES	FRD S8 FR ES	FRD S9 FR ES	FRD R912 FR ES	FRD S10 FR ES	FRD R1015 FR ES	FRD S12 FR ES	FRD S15 FR ES
Electric Opening Product Code (Electric Remote)									
Clear	FRD S6 ER	FRD R69 ER	FRD S8 ER	FRD S9 ER	FRD R912 ER	FRD S10 ER	FRD R1015 ER	FRD S12 ER	FRD S15 ER
Frosted	FRD S6 FR ER	FRD R69 FR ER	FRD S8 FR ER	FRD S9 FR ER	FRD R912 FR ER	FRD S10 FR ER	FRD R1015 FR ER	FRD S12 FR ER	FRD S15 FR ER

Note: Additional sizes are available upon request, for further information please contact the Keylite Technical Team.



Flat Roof Access Hatch

FRD-AH



The Keylite Flat Roof Access Hatch is designed to allow access to and from roof areas and can form part of a fire escape route.

The hinged frame opens to 80° to allow a safe route for personnel and equipment, while often avoiding the need to provide other external facilities.



Features

- All the standard Flat Roof Dome features are available with the added benefit of a safe access route.
- Telescopic gas struts.
- Available with either internal or external locking mechanisms.
- Excellent insulating value and sound reduction.

Flat Roof Dome Code	S10	R912	S12
Size WxL (mm)	1000x1000	900x1200	1200x1200
Structural Opening Sizes	1025x1025	925x1225	1225x1225
Access Hatch Product Codes			
Clear	FRD S10 AH	FRD R912 AH	FRD S12 AH
Frosted	FRD S10 FR AH	FRD R912 FR AH	FRD S12 FR AH

Note: Additional sizes are available upon request, for further information please contact the Keylite Technical Team.

Flat Roof Smoke Ventilation FRD-AOV



The Keylite Flat Roof Smoke Ventilators are electrically operated smoke vents designed to allow the release of smoke from buildings in the event of a fire.

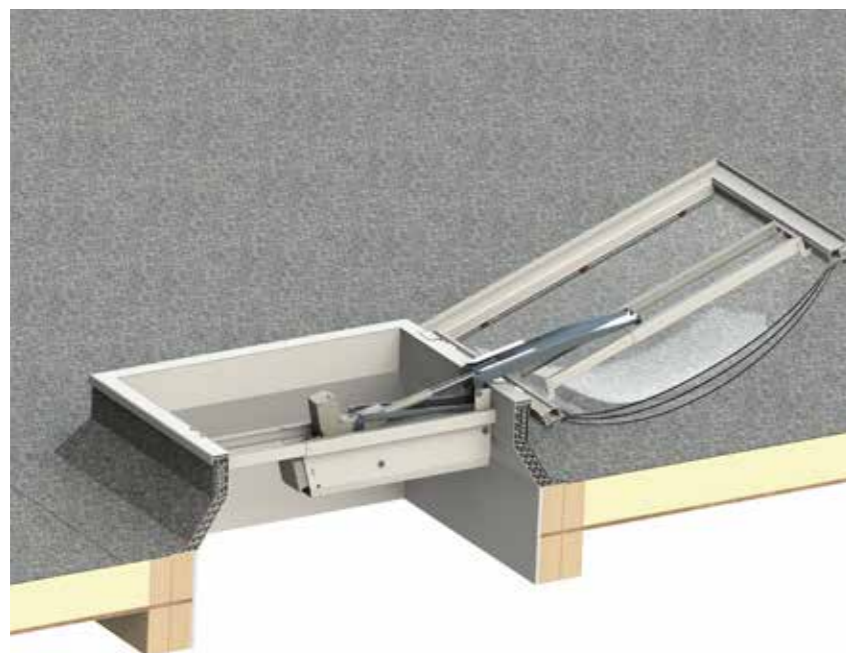

Features

- All Keylite Flat Roof Smoke Ventilators and smoke controls are fully tested and compliant with EN 12101-2, EN 12101-9, and EN 12101-10.
- Wide range of sizes available to provide opening vents with Smoke Ventilation areas of 0.88m², 1.0m² & 1.5m²
- Opens to 160° within 60 seconds.
- Accessories include control panels, detectors and manual control points.
- Actuator can be off set for access purposes as well.
- 300mm PVC upstand.

Flat Roof Dome Code	S10	S125	S15	R1218
Size WxL (mm)	1000x1000	1250x1250	1500x1500	1200x1800
Structural Opening Sizes	1025x1025	1275x1275	1525x1525	1225x1825
Smoke Ventilation Area (m ²)	0.88	1.0	1.5	1.5
Smoke Ventilation Product Codes				
Clear	FRD S10 AOV	FRD S125 AOV	FRD S15 AOV	FRD R1218 AOV
Frosted	FRD S10 FR AOV	FRD S125 FR AOV	FRD S15 FR AOV	FRD R1218 FR AOV

Note: Additional sizes are available upon request, for further information please contact the Keylite Technical Team.

Smoke Ventilation Roof Windows SVK



The Keylite Smoke Ventilation System is designed to open a Keylite Roof Window automatically, in the event of a fire.



Features

- The system is also provided with a 3-day battery back-up should the building's electrical system fail.
- This system integrates seamlessly with a building's fire alarm interface, or can operate independently as a stand alone system.
- Please visit the Keylite website to view wiring diagrams.
- Additional functionality inspection available. Please contact the Keylite Technical Department for further information and assistance.

Kit Includes:

- Motor(s), Control Panel, Break Glass, Smoke Sensor & 3 day battery back-up pack. Roof Window & flashing not included.
- To provide 1m² Smoke Ventilation the SVK should be added to a Keylite CP08 (1140 x 1180mm) window type and flashing.
- To provide 1.5m² Smoke Ventilation the SVK should be added to a Keylite CP10 (1340 x 1400mm) window type and flashing.
- When SVK + window are ordered together, the motor is factory fitted free of charge.



Size Code	03	04	05	06	07F	07	08	09	10
Size WxH (mm)	660x1180	780x980	780x1180	780x1400	940x1400	940x1600	1140x1180	1340x980	1340x1400
Smoke Ventilation Area m ²	0.57	0.55	0.69	0.84	1.03	1.20	1.04	0.98	1.50
SVK	SVK	SVK	SVK	SVK	SVK	SVK	SVK	SVK	SVK

Note: Alternative sizes are also available, for further information, please contact the Keylite Technical Department

Sunlite Light Tube System SL

10
Year
Guarantee

A Keylite Sunlite transports natural daylight into areas where conventional pitched or flat roof windows cannot be used.

The highly reflective light tube enables daylight to travel from the roof to an interior space deprived of natural light. Keylite recommend a minimum 350mm diameter Rigid Light Tube System to achieve 98% reflectance.



Benefits

- Available with a 'rigid' or 'flexible' light tube, to suit your roof design.
- Saves on energy and transforms dark or windowless rooms. Ideal for bathrooms, stairways and corridors.
- Double glazed ceiling diffuser with white ceiling trim.
- Reduces the need for additional ceiling fittings by integrating the fluorescent lamp option to any Sunlite rigid and flexi system.

A Keylite Sunlite includes:

- Roof flashing and covering.
- Preferred tubing - rigid or flexi (rigid recommended).
- White ceiling diffuser.
- Flat Roof upstand (SLRSF only).

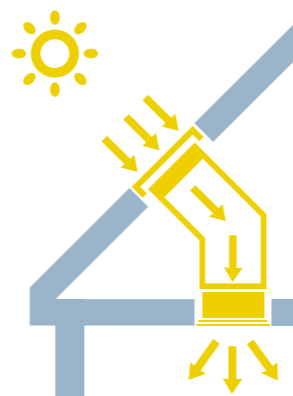

Pitched Roof Sunlite System SLRS / SLFS



Features

- Magnetic fixings allow for quick installation and easy cleaning of the ceiling diffuser.
- Click fit installation.
- Exterior Self-Cleaning Glass ensuring maximum daylight is achieved and is simple to maintain.
- Ventilated with unique fittings at both roof and ceiling levels, which combat the risk of condensation

Recommended Use

- **250mm Diameter**
Bathroom, WC, small hallway.
Suitable for rooms up to 3m x 3m.
- **350mm Diameter**
Bathroom, en suite, hall.
Suitable for rooms up to 4m x 4m.
- **450mm Diameter**
Bathroom, office, hall, corridor.
Suitable for rooms up to 5m x 5m.
- **530mm Diameter**
Living room, office, kitchen, hallway.
Suitable for areas of 6m x 6m.



Rigid system

SLRSS - For slate installation.
SLRST - For profiled or flat tile installation.

For optimum performance

Keylite's rigid tube system is made using a hard wearing, mirror finished, polished aluminium tube with 98% reflectance.

Size	Tile Product Code	Slate Product Code
250mm ø	SLRST 250	SLRSS 250
350mm ø	SLRST 350	SLRSS 350
450mm ø	SLRST 450	SLRSS 450
530mm ø	SLRST 530	SLRSS 530

Tube length 2m



Flexi system

SLFSS - For slate installation.
SLFST - For profiled or flat tile installation.

For versatility

Recommended for installations where obstructions within the roof prohibit the use of a rigid system. This system offers 83% reflectance.

Size	Tile Product Code	Slate Product Code
250mm ø	SLFST 250	SLFSS 250
350mm ø	SLFST 350	SLFSS 350
450mm ø	SLFST 450	SLFSS 450
530mm ø	SLFST 530	SLFSS 530

Tube length 2m



Sunlite Accessories

Mechanical ventilation is available as an option, please contact the Keylite Technical Team for more information.

Size (mm)	250	350	450	530
Rigid Extension 625mm	SLRE 250	SLRE 350	SLRE 450	SLRE 530
Circular Fluorescent Lamps	SLL	SLL	SLL	SLL

Note: When placing your order please specify slate or tile flashing. If roof void is more than 2m, please call the Keylite Technical Team.

Flat Roof Sunlite System SLRSF

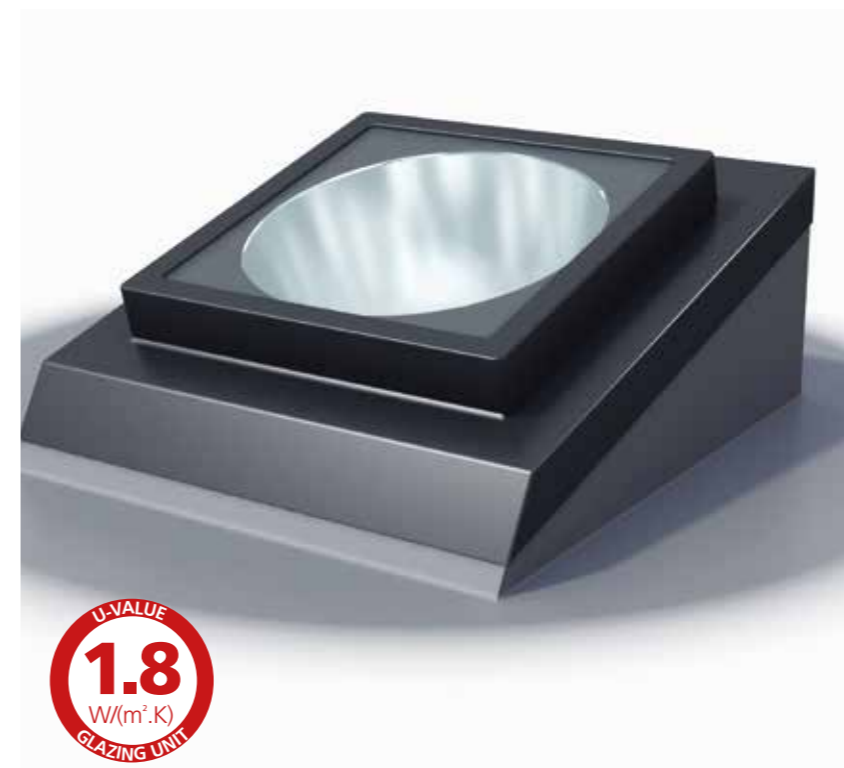

Features

- Inclusive of all the innovative features of a Sunlite.
- The Keylite Flat Roof Sunlite is now supplied with a unique timber insulated upstand as standard to ensure the installation is as simple as possible.

Rigid System

Our rigid system uses Alanod Miro Silver with a total reflection of 98%. It provides highly efficient illumination with low transmittance loss. Moreover, it is extremely hard-wearing, does not fade and does not lose its reflective power.

Recommended Use

- **350mm Diameter**
Bathroom, en suite, WC, hall, small staircase. Suitable for rooms up to 4m x 4m.
- **450mm Diameter**
Bathroom, office, hall, corridor. Suitable for rooms up to 5m x 5m.
- **530mm Diameter**
Living room, office, kitchen, hallway. Suitable for areas of 6m x 6m.



Size	Product Code
250mm ø	SLRSF 250
350mm ø	SLRSF 350
450mm ø	SLRSF 450
530mm ø	SLRSF 530

Tube length 800mm

Size (mm)	250	350	450	530
Rigid Extension 625mm	SLRE 250	SLRE 350	SLRE 450	SLRE 530
Circular Fluorescent Lamps	SLL	SLL	SLL	SLL

Note: If roof void is more than 800mm, please call the Keylite Technical Team.

Single Window Flashings

Keylite Flashing Kits are the most efficient way to ensure a watertight installation for your windows and have been designed to integrate efficiently with specific roofing materials.

The installer friendly instructions and one-piece bottom apron ensure easy first time fitting. The unique one-piece bottom apron design improves aesthetic finish and allows for easy installation.

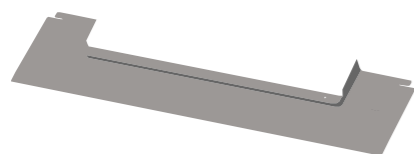

Tile: TRF

- **Roof Pitch 20° – 90°**
- **Material Profile - Max 45 mm**
- Flashing for single window installation into interlocking profiled tiles or interlocking plain tiles.

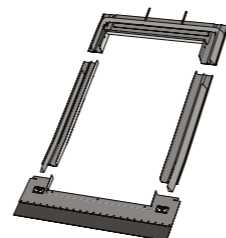
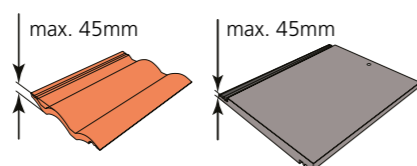

Deep Tile: DTRF

- **Roof Pitch 15° – 90°**
- **Material Profile – Max 90mm**
- Flashing for single window installation into flat or profiled interlocking tiles. Also suitable for interlocking slate and profiled sheeting.

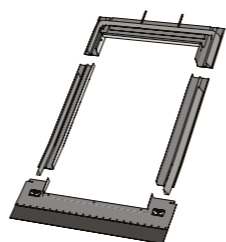
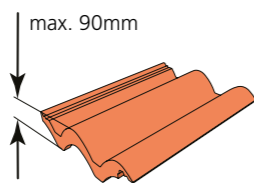

Slate: SRF

- **Roof Pitch 15° – 90°**
- **Material Profile – Max 10mm**
- Flashing for single window installation into slate up to 10mm thick.

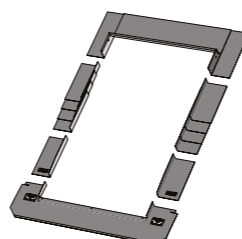
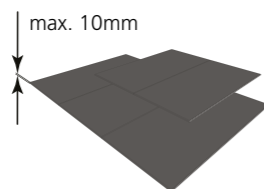

Not to be used with interlocking slate.

Plain Tile: PTRF

- **Roof Pitch 25° – 90°**
- **Material Profile – Max 15mm**
- Flashing for single window installation into plain tiles.

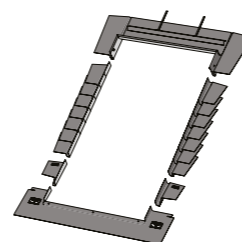
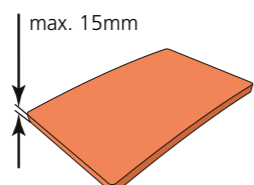

Not to be used with interlocking plain tiles.

Combination Flashings

The Keylite range of Combination Flashing Systems allows any of the standard Keylite Roof Windows to be installed in vertical, horizontal or group blocks.

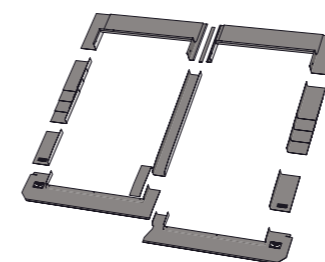

Features	Combinations
<ul style="list-style-type: none"> • Standard distance between window frames = 100mm • Variations and specials on request, please contact Keylite Sales Team for more information 	<ul style="list-style-type: none"> • Side by Side Combi • Over and Under Bi-Lite • 2x2 Square Quad-Lite

	01	02	01C	03	04	05	06	07F	07	08	09	10
Size Code												
Size WxH (mm)	550x780	550x980	550x1180	660x1180	780x980	780x1180	780x1400	940x1400	940x1600	1140x1180	1340x980	1340x1400
Slate 8mm Profile	SRF 01	SRF 02	SRF 01C	SRF 03	SRF 04	SRF 05	SRF 06	SRF 07F	SRF 07	SRF 08	SRF 09	SRF 10
Tile 45mm Profile	TRF 01	TRF 02	TRF 01C	TRF 03	TRF 04	TRF 05	TRF 06	TRF 07F	TRF 07	TRF 08	TRF 09	TRF 10
Deep Tile 90mm Profile	DTRF 01	DTRF 02	DTRF 01C	DTRF 03	DTRF 04	DTRF 05	DTRF 06	DTRF 07F	DTRF 07	DTRF 08	DTRF 09	DTRF 10
Plain Tile 15mm Profile	PTRF 01	PTRF 02	PTRF 01C	PTRF 03	PTRF 04	PTRF 05	PTRF 06	PTRF 07F	PTRF 07	PTRF 08	PTRF 09	PTRF 10
Conservation Slate	CWSRF 01	CWSRF 02	CWSRF 01C	CWSRF 03	CWSRF 04	CWSRF 05	CWSRF 06	CWSRF 07F	CWSRF 07	CWSRF 08	CWSRF 09	CWSRF 10
Conservation Tile Product Code	CWTRF 01	CWTRF 02	CWTRF 01C	CWTRF 03	CWTRF 04	CWTRF 05	CWTRF 06	CWTRF 07F	CWTRF 07	CWTRF 08	CWTRF 09	CWTRF 10
Conservation Plain Tile	CWPTRF 01	CWPTRF 02	CWPTRF 01C	CWPTRF 03	CWPTRF 04	CWPTRF 05	CWPTRF 06	CWPTRF 07F	CWPTRF 07	CWPTRF 08	CWPTRF 09	CWPTRF 10
Combi Slate Product Code	CSRF 01	CSRF 02	CSRF 01C	CSRF 03	CSRF 04	CSRF 05	CSRF 06	CSRF 07F	CSRF 07	CSRF 08	CSRF 09	CSRF 10
Combi Tile 15-90mm Profile	CTRF 01	CTRF 02	CTRF 01C	CTRF 03	CTRF 04	CTRF 05	CTRF 06	CTRF 07F	CTRF 07	CTRF 08	CTRF 09	CTRF 10
Bi-Lite Slate Product Code	BLSRF 01	BLSRF 02	BLSRF 01C	BLSRF 03	BLSRF 04	BLSRF 05	BLSRF 06	BLSRF 07F	BLSRF 07	BLSRF 08	BLSRF 09	BLSRF 10
Bi-Lite Tile 15-90mm Profile	BLTRF 01	BLTRF 02	BLTRF 01C	BLTRF 03	BLTRF 04	BLTRF 05	BLTRF 06	BLTRF 07F	BLTRF 07	BLTRF 08	BLTRF 09	BLTRF 10
Quad-Lite Slate Product Code	QLSRF 01	QLSRF 02	QLSRF 01C	QLSRF 03	QLSRF 04	QLSRF 05	QLSRF 06	QLSRF 07F	QLSRF 07	QLSRF 08	QLSRF 09	QLSRF 10
Quad-Lite Tile 15-90mm Profile	QLTRF 01	QLTRF 02	QLTRF 01C	QLTRF 03	QLTRF 04	QLTRF 05	QLTRF 06	QLTRF 07F	QLTRF 07	QLTRF 08	QLTRF 09	QLTRF 10

Enhanced Installation Components



Keylite Vapour Collar

The Keylite Vapour Collar (VC) enhances the air tightness around your Keylite roof window, as well as preventing vapour passing through your roof construction.

Keylite Felt Collar

The Keylite Felt Collar (FC) is manufactured from a flexible material that creates an impenetrable seal around your roof window and unites with the underfelt of your roof to ensure a watertight seal.

Size Code	01	02	01C	03	04	05	06	07F	07	08	09	10
Size WxH (mm)	550x780	550x980	550x1180	660x1180	780x980	780x1180	780x1400	940x1400	940x1600	1140x1180	1340x980	1340x1400
Felt Collar												
FC Product Code	FC 01	FC 02	FC 01C	FC 03	FC 04	FC 05	FC 06	FC 07F	FC 07	FC 08	FC 09	FC 10
Vapour Collar												
VC Product Code	VC 01	VC 02	VC 01C	VC 03	VC 04	VC 05	VC 06	VC 07F	VC 07	VC 08	VC 09	VC 10
Installation Package												
IPC Includes FC and VC	IPC 01	IPC 02	IPC 01C	IPC 03	IPC 04	IPC 05	IPC 06	IPC 07F	IPC 07	IPC 08	IPC 09	IPC 10

Roof Window Support Trims

Keylite Roof Window Support Trims are designed to offer increased structural support, and provide an enhanced aesthetic appearance to roof windows that are installed side by side.

Keylite Product Code	Description
ST 100x1200	Pine Support Trimmer 100mm Spacing 1200mm long
ST 100x1600	Pine Support Trimmer 100mm Spacing 1600mm long
ST 100x2000	Pine Support Trimmer 100mm Spacing 2000mm long
ST 50x1200	Pine Support Trimmer 50mm Spacing 1200mm long
ST 50x1600	Pine Support Trimmer 50mm Spacing 1600mm long
ST 50x2000	Pine Support Trimmer 50mm Spacing 2000mm long
ST 18x1200	Pine Support Trimmer 18mm Spacing 1200mm long
ST 18x1600	Pine Support Trimmer 18mm Spacing 1600mm long
ST 18x2000	Pine Support Trimmer 18mm Spacing 2000mm long
WFST 100x1200	White Support Trimmer 100mm Spacing 1200mm long
WFST 100x1600	White Support Trimmer 100mm Spacing 1600mm long
WFST 100x2000	White Support Trimmer 100mm Spacing 2000mm long
WFST 50x1200	White Support Trimmer 50mm Spacing 1200mm long
WFST 50x1600	White Support Trimmer 50mm Spacing 1600mm long
WFST 50x2000	White Support Trimmer 50mm Spacing 2000mm long
WFST 18x1200	White Support Trimmer 18mm Spacing 1200mm long
WFST 18x1600	White Support Trimmer 18mm Spacing 1600mm long
WFST 18x2000	White Support Trimmer 18mm Spacing 2000mm long

Available in a choice of Pine or White, our support trims provide the perfect interior finish.

*Additional lengths of 2700mm & 3500mm available upon request, for further information on these please contact the Keylite Technical Department.



Genuine Keylite Blinds



Create atmosphere with our specially designed Style Collection blinds. Control, block and soften daylight for every mood and every space at home.

Keylite Blinds are used across a diverse range of interiors, whether it is a living room, bedroom, home office, a home gym, or some other completely unique space that requires some love and attention. You can make the most of any interior space simply by adding colourful, bright Keylite Blinds from our Style Collection which brings together a range of colours, patterns and fabric options.

Follow the simple steps below to order your Keylite Blinds

STEP 1

Identify the serial number

Locate the **serial number** on the silver identification card, under the ventilation handle (e.g. 021508090).



STEP 2

Fabric Choice.

- Blackout blinds
- Dimout blinds
- Moisture Resistant blinds

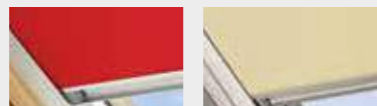

STEP 3

Operation Choice

- Solar
- Electric
- Manual

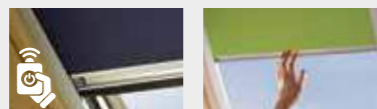

STEP 4

Surround Choice

- **White Finish Surround**
The perfect complement to your White Finish windows.



- **Aluminium Surround**
Ideal with Pine Windows for a contemporary finish.



ORDER ONLINE
www.keyliteblinds.com



E-MAIL ENQUIRIES
sales@keyliteblinds.com



ORDER HOTLINE
UK: +44 (0)12 8320 0197
NI & ROI : +44 (0)28 8676 7515



Practical Features

Order online at
www.keyliteblinds.com



Unique Design
Keylite blinds come with slim aluminium side rails for smooth operation and a clean classic look. This also gives increased natural light when the blinds are open.

Cord free
100% child friendly

Fully enclosed cassette
Protects fabric from discolouration and eliminates light glow around the edge.

Energy efficient
Controls solar heat gain. Thermal benefits reduce heat loss by at least 20%. (BBA Tested)

Fabric Options
Available as blackout, dimout and moisture resistant.

Fingertip control
Easy and smooth operation.

Fully encased side rails
Brush seals provide 100% blackout and improve thermal efficiency.

Surround Choice
White Finish Surround - The perfect complement to your White Finish windows.
Aluminium Surround - Ideal with Pine Windows for a contemporary finish.

Upgrade to Solar
Our solar powered and electric blinds are ideal for those out of reach locations from the comfort of your armchair or bed.

Operation



Manual Operation
Our one touch control allows for effortless positioning of the blind by hand.



Electric Operation
Our complete range of blinds are available with remote control electric operation (on a PEK electrically operated window). Our electric blinds are ideal for those out of reach roof window positions.



Solar Operation
Our complete range of blinds are available with solar control for manually operated windows. Solar powered remote control blinds are available for all those out of reach areas. It's easy to install with no wiring required.

Fabric Options



Blackout Blinds
Ideal choice for bedrooms and cinema rooms.

We offer an extensive range of blackout blinds, all of which include thermal fabric as standard, for extra cosiness and warmth. Leave them open and you can let the light in, but once they are closed you will enjoy completed darkness and of course extra warmth thanks to the unique thermal fabric.



Dimout Blinds
Ideal choice for living rooms and landings.

For those who want to transform their home into a place of restful relaxation, then the dimout blind is the perfect choice. Fully drawn, this blind simply diffuses light to provide a warm and cosy feel, far away from the glare of the world outside, whilst still allowing light to softly permeate through the fabric.



Aqua - Moisture Resistant Blinds
Ideal choice for bathrooms and kitchens.

Our wipe clean, PVC moisture resistant fabrics offer the perfect solution for any space. No more stains, no more odours, just blinds that can stand the test of time in your home.



Kid's Range
Ideal choice for a child's bedroom.

A kid's bedroom should be a place that makes them feel happy and a place where they can let loose with their imagination; for kids, life is all about learning through play, so why not turn their bedroom into their own unique little kingdom?

Blackout Blinds

Manual | Solar | Electric



Features

- Include thermal fabric as standard, for extra cosiness and warmth. Thermal benefits - reducing heat loss by at least 20% (BBA tested).
- Side rails for total 100% blackout.
- 100% safety focused cordless operation for peace of mind in the home.
- Leave them open and you can let the light in, but once they are closed you will enjoy complete darkness.

ESSENTIALS Neutral tones to complement most interior spaces



DECOR Stylish colours for unique interiors



AQUA Moisture resistant PVC fabrics

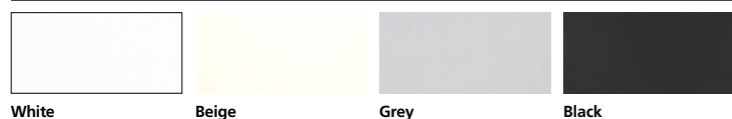

KIDS Vibrant patterns for fun interiors

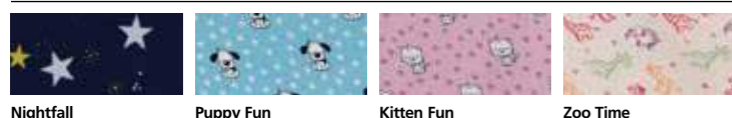

Dimout Blinds

Manual | Solar | Electric

Order online at www.keyliteblinds.com



Features

- For those who want to transform their home into a place of restful relaxation, then the dimout blind is the perfect choice.
- Roller cover prevents fading of coloured fabrics.
- 100% safety focused cordless operation for peace of mind in the home.
- Fully drawn, this blind simply diffuses light to provide a warm and cosy feel, far away from the glare of the world outside, whilst still allowing light to softly permeate through the fabric.

ESSENTIALS Neutral tones to complement most interior spaces



DECOR Stylish colours for unique interiors



INTRODUCING Solar Blinds



Powered by the sun
free energy

Easy Fitting
no wiring,
no electrician

Controlled
by hand held remote



Innovative

- After extensive development and testing we are pleased to announce the launch of the NEW Solar powered Keylite Blind.
- This innovative feature puts Keylite right at the forefront of blinds technology and is the simple answer to opening and closing blinds in areas difficult to access.

Free Energy

- The solar blind is controlled with a hand held remote control.
- The solar panel is located in the cassette and collects energy from the sun which then provides a trickle charge to the battery.

Easy Install

- The installation process does not involve wiring or tracking the walls for mains electric, for ease of fitting.
- The battery pack, the motor for powering the blind, and the roller for holding the blind fabric are contained in a cassette secured to the top of the window sash.

Electric and Solar Blinds Blackout | Dimout

Order online at
www.keyliteblinds.com



Features

- Our complete range of blinds are available with remote control electric operation (on a PEK electrically operated window).
 - Our solar and electric blinds are ideal for those out of reach positions.
 - Roller cover prevents fading of coloured fabrics.
- Available in blackout
 - Available in dimout

ESSENTIALS Neutral tones to complement most interior spaces

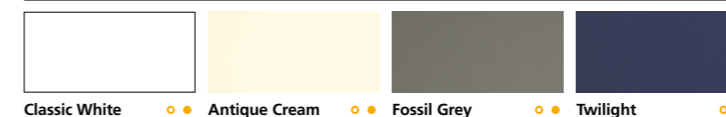

DECOR Stylish colours for unique interiors



AQUA Moisture resistant PVC fabrics



KIDS Vibrant patterns for fun interiors

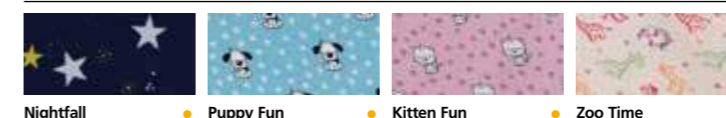

Kid's Blinds

Manual | Solar | Electric



Accessories

Order online at www.keyliteblinds.com



Kid's Blinds

- Make the most of roof windows in this room by simply adding fun blinds specifically designed for children. We all know that every child loves the sanctuary of their own bedroom, so help them to have even more fun simply by using bright, vibrant colours, and fun interior design elements.

Choose Blackout

- We all know the value of great night time sleeping habits for children. Not only is a long night's sleep essential for each individual child, it is also conducive to a much happier family unit.
- We offer a great variety of colourful, fun, blackout blinds which are perfect for brightening up a child's bedroom - many of them include the additional thermal option for extra cosiness at no extra cost... perfect for ensuring that your little ones get a great nights' sleep.

Safety Features

- Our blinds are designed to be Child Safe with no dangerous cords or chains which could cause injury.
- Choose accessories such as our Restrictor and Security Lock to provide extra child safety for extra peace of mind.

KIDS Vibrant patterns for fun interiors

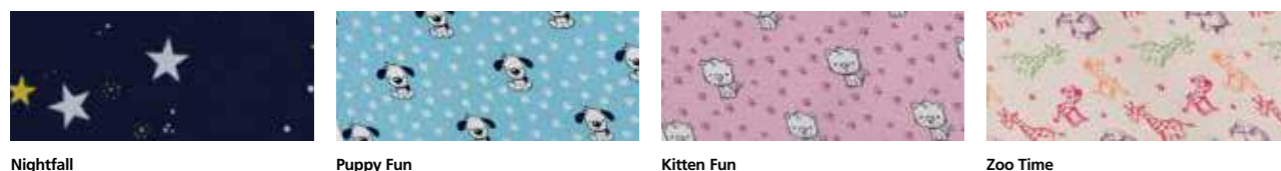

Nightfall

Puppy Fun

Kitten Fun

Zoo Time



Opening Pole (Blinds Control)

Manually control your window and blind with a telescopic opening pole. The telescopic pole is available in 2m and 3m lengths.

Integral Blind Opening Pole

Manually control your integral blind with a 2m long opening pole.



Security Lock

A Keylite security lock can be fitted for added security.



Key Operated



Opening Restrictor

For added safety, a Keylite opening restrictor is available.



Key Operated

Loft Ladder

LL



The Keylite Loft Ladder is designed to ensure simple, fast installation.

With pre-installed Flick-Fit brackets, allowing installation from below the loft, and with a unique detachable ladder which enables a one-person installation, the Keylite Loft Ladder is designed to make your life easier.

Features

- Flick-Fit installation - Pre-installed brackets for installation from below
- Continuous seal around trapdoor reduces heat loss
- Pre-fitted handrail as standard
- White 36mm thick insulated trapdoor, with U-Value of 1.1W/(m².K) as standard*
- Unique detachable ladder enables a one person install

- Recessed locking system
- Slip resistant treads
- Dovetail joints on all treads
- Scratch resistant protective feet
- All Keylite loft ladders are draught proof and have obtained the highest air tightness classification possible, Class 4

Fire Resistant Loft Ladder

- A Loft ladder with a 30 minute fire rating, ideal for meeting specific building regulations

For further details contact the Keylite Technical Team.

3 Segment Ladder

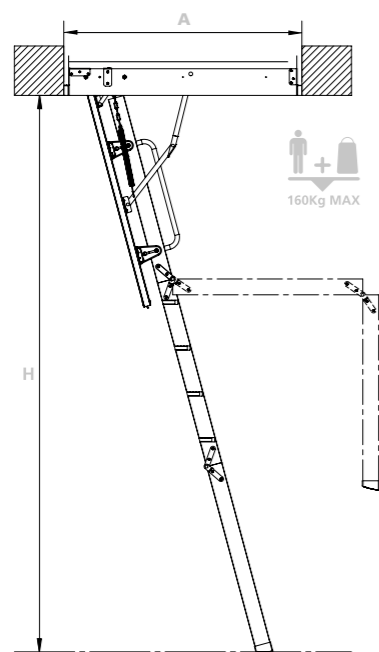

4 Segment Ladder

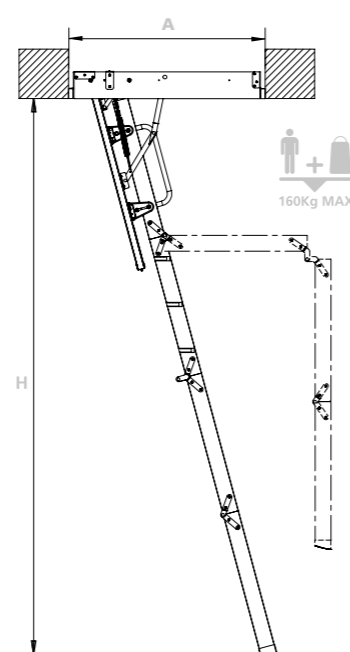

Product Code	KYL 01	KYL 02	KYL 03	KYL 04	KYL 05	KYL 06	KYL 07	KYL 08	KYL 09
A Ceiling opening dimension (mm)	550x1000	550x1200	550x1200	600x1000	600x1200	600x1200	700x1000	700x1200	700x1200
B Frame external dimension (mm)	530x940	530x1140	530x1140	580x940	580x1140	580x1140	680 x 940	680 x 1140	680 x 1140
Number of ladder sections	4	3	4	4	3	4	4	3	4
C (mm)	1025	1025	1145	1025	1025	1145	1025	1025	1145
R (mm)	1300	1565	1605	1300	1565	1605	1300	1565	1605
H (mm)	2800	2800	3200	2800	2800	3200	2800	2800	3200



FAST-EASY
ONE PERSON INSTALLATION

Continuous seal around trapdoor reduces heat loss

Flick-Fit Installation
Pre-installed brackets for installation from below

Pre-fitted handrail as standard

White 36mm thick insulated trapdoor, with U-Value of 1.1W/(m².K) as standard*

Unique Innovation

Unique detachable ladder enables one person to install

Recessed locking system

Slip resistant treads

Scratch resistant protective feet

Dovetail joints on all treads

*U-Value determined by calculation

Installation Instructions

Full instructions and installation videos are available to download on

www.keyliteroofwindows.com

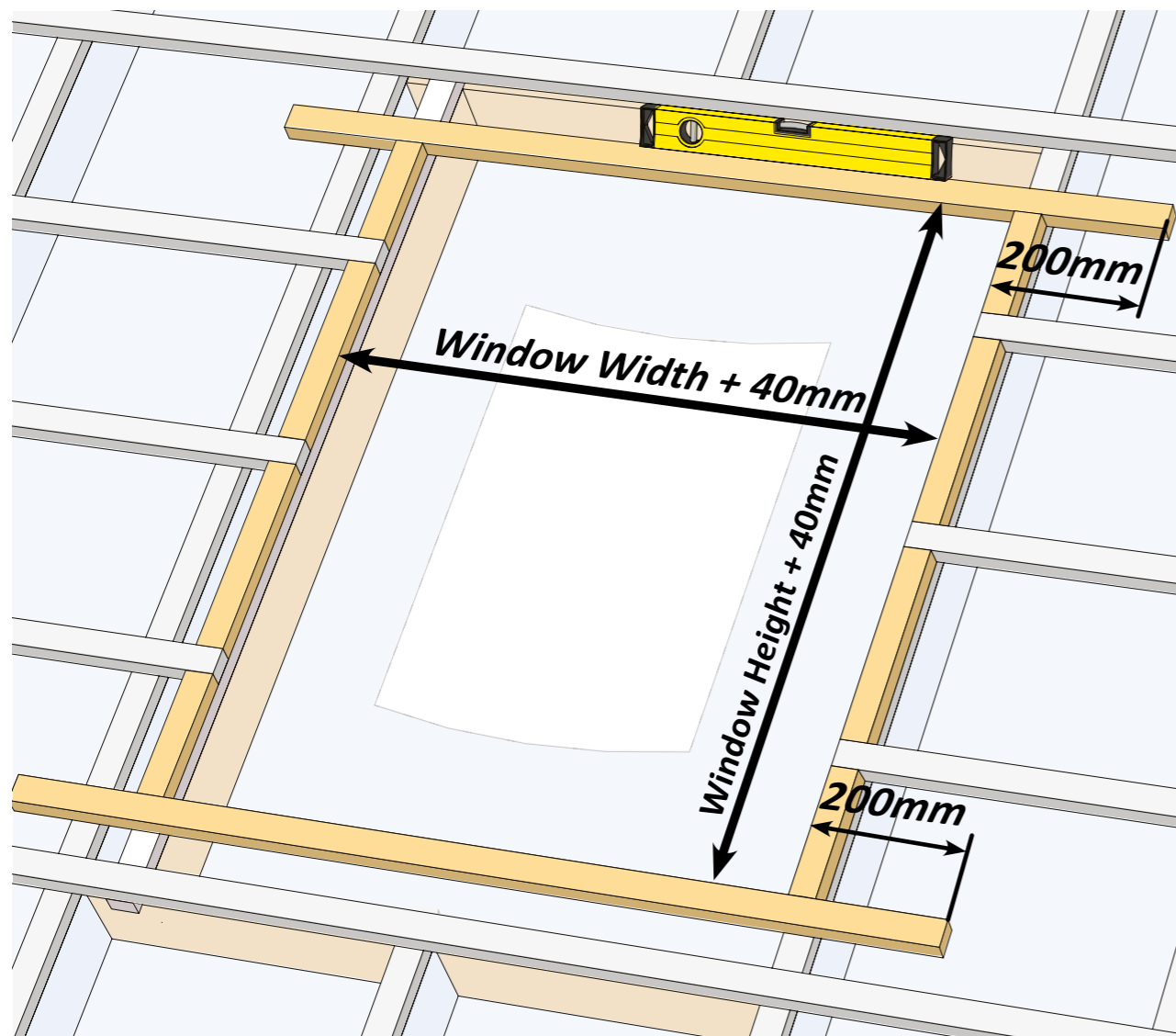

Note

40mm allowance must be given for the roof window opening (leaving a 20mm gap between window frame and batten). This ensures room for alignment and maximises the performance of Keylite roof windows.

Example: CP 04 T

The outermost dimension of every Keylite Roof Window is printed on our packaging labels. For a CP-04-T window, the width of the opening in the roof must be:

780mm (+40mm) X 980mm (+40mm)
= **820mm X 1020mm**

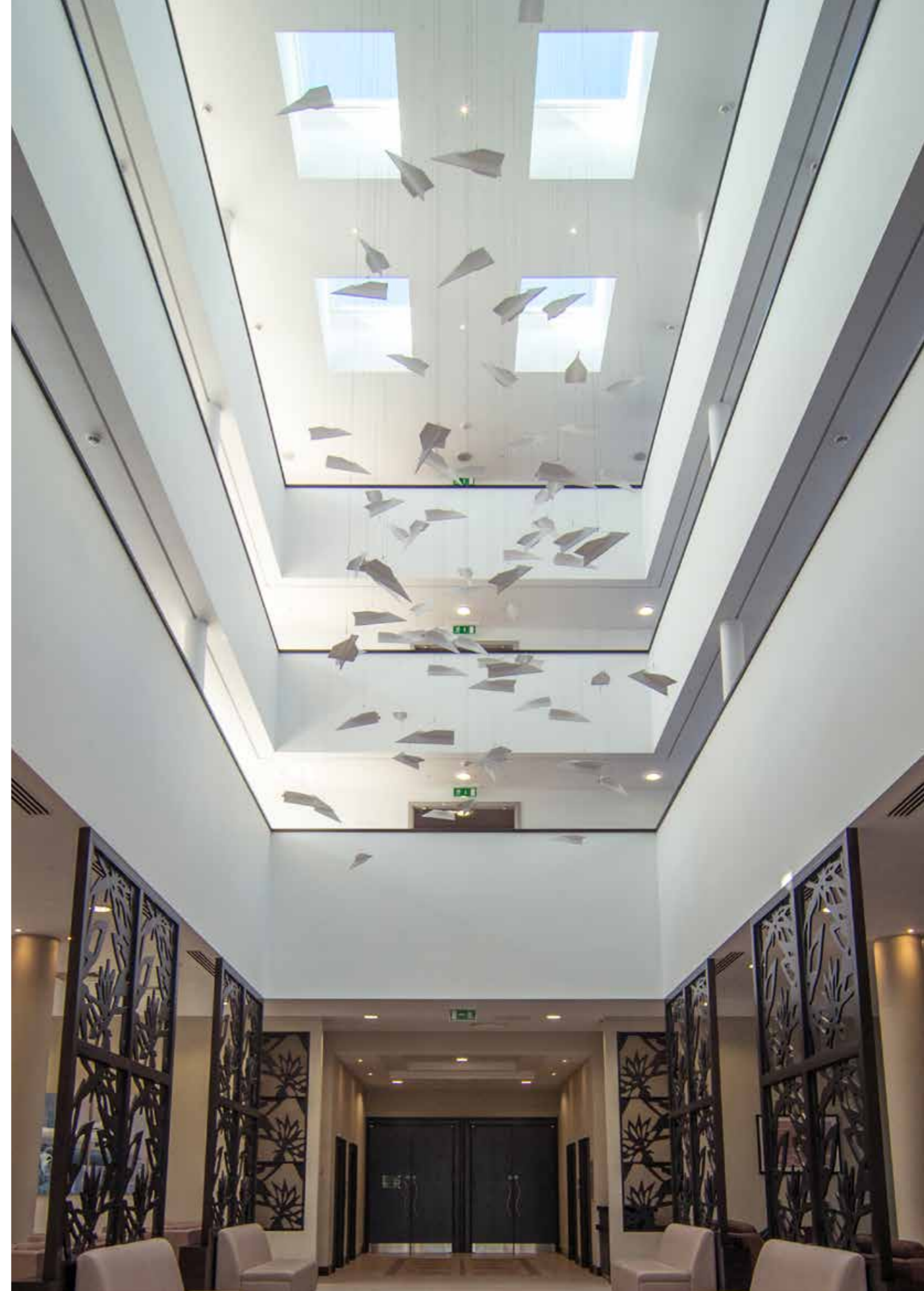
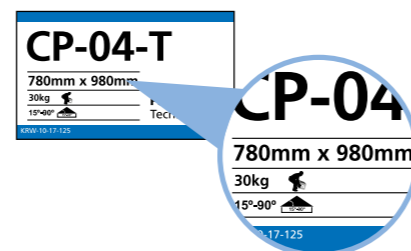



UK

Ryder Close, Cadley Hill Industrial Estate,
Swadlincote, South Derbyshire, DE11 9EU

T: +44 (0) 1283 200 158
E: info@keyliteuk.com

NI & ROI

Derryloran Industrial Est. Sandholes Road,
Cookstown, Co. Tyrone, BT80 9LU

T: +44 (0) 28 8675 8921
E: info@keylite.co.uk

keyliteroofwindows.com